



Optional Long Shroud

PROJECT

CATALOG #

TYPE

NOTES

LR Up Light

The redesigned LR copper/brass up light continues its legacy as a beautiful, robust addition to lighting projects in coastal environments.

Quick Facts

- Copper/brass construction
- Natural copper/brass or antique finishes
- Accepts MR-16 lamps
- ProAim™ adjustability
- Phase and PWM dimmable
- Input voltage: 10-15V

Luminaire Classification

Series	Base	Plus	Premium
Designer	<input type="checkbox"/>	<input type="checkbox"/>	<input type="checkbox"/>
Standard	<input type="checkbox"/>	<input type="checkbox"/>	<input checked="" type="checkbox"/>

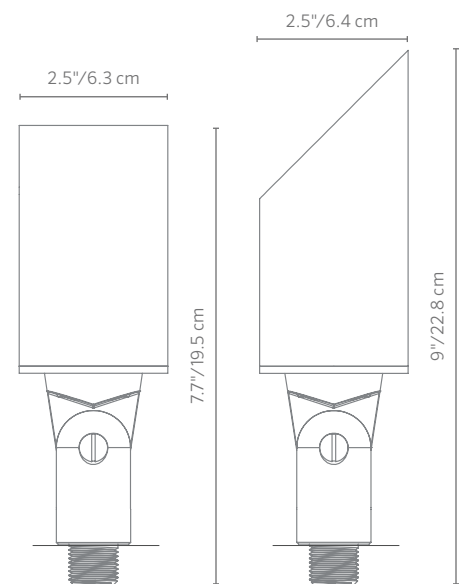

LR Up Light SPECIFICATIONS

Output	LED20W	LED35W
Total Lumens	240	335
Input Voltage	10 to 15V	10 to 15V
Input Power:	4.0W	5.0W
VA (Use this number to size the transformation)	4.3W	5.4W
Lumens per Watt (Efficacy)	60	67
CRI (Ra)	81	81
Dimming	Phase**	Phase**
ZD Option	Use ZD MR-16 Lamp	Use ZD MR-16 Lamp
Minimum Rated Life (Hrs, L70)	40,000 Hrs	40,000 Hrs

** For optimal performance, use a trailing edge phase cut dimmer.

FX Luminaire

FX Luminaire is an industry-leading manufacturer of landscape and architectural lighting products with a focus on the advancement of LED technology and digital lighting control with zoning, dimming, and color adjustment capabilities. We offer a full spectrum of highly efficient lighting fixtures that can be utilized to create elegant, cutting-edge landscape lighting systems for commercial or residential applications. Our products are available exclusively via our extensive professional distributor network.

Materials

Die-cast C360 brass knuckle/bass assembly with brass hardware and machined angled glass support. C110 extruded copper shroud.

Lamp

GU5.3 lamp base.

Preinstalled MR-16 LED lamp option offers a warm 2,700K color temperature with a minimum rated life (L70) 40,000 hours.

Socket

GU5.3 (GU4) socket with retaining clips for MR-16 lamps. Ceramic socket base with heat-resistant contact pad. Stainless steel retaining clips ensure high spring force retention.

Wiring

18 AWG SPT-1W 105°C 300V 3-meter length.

Power

Input 10-15VAC/VDC 50/60Hz. Remote transformer required (specify separately).

Lens

Tempered glass lens with shock resistance and high tolerance for thermal expansion and stress.

Finish

Two-layer protection of sulfuric acid anodization and

polyester TGIC powder coat, providing superior outdoor weathering in all conditions. Tested to ASTM standards.

Weight

2.05 lbs.

Manufacturing

9001:2015 certified facility.

Hardware

¼-20 x ¾" brass angle lock screw. Includes ProAim™ ratcheting ABS spike for 360° horizontal rotation in 10° increments. Tamper-resistant locking screw included.

Ambient Operating Temperature

0°F to 140°F

Control

ZDlink or ZDClink utilizes Luxor® technology to zone light fixtures in up to 250 groups, dim each group in 1% increments between 0 and 100%, or change to one of 30,000 colors with RGBW LEDs. Select the

ZD option for zoning/dimming or ZDC for zoning/dimming/color. Standard fixture is zoneable with ZDlink or ZDClink.

Sustainability

Innovation meets conservation in the design and manufacturing of our products. Where we can, we use recycled materials while maintaining superior functionality. Our LED products provide high-quality light at optimal energy efficiency, lifespan, and durability.

Installation Requirements

Designed for installation in the upward direction only.

ISO

9001:2015 certified facility



Warranty

10-year limited warranty on luminaire; 5-year limited warranty on preinstalled FX LED lamp; no warranty on incandescent or halogen lamp.

Listings



LR Up Light ORDERING INFORMATION

Fixture Size	Lamp Option	Shroud	Finish
LR	<ul style="list-style-type: none"> NL No Lamp 	<ul style="list-style-type: none"> [blank] Default Straight Cutoff Shroud 	<ul style="list-style-type: none"> CU Copper 
	<ul style="list-style-type: none"> 20 20W Halogen Lamp 	<ul style="list-style-type: none"> LS Long Shroud (45°) 	<ul style="list-style-type: none"> NP Nickel Plate 
	<ul style="list-style-type: none"> LED20WFL 20W Equivalent LED Lamp, 2,700K, 35° 		
	<ul style="list-style-type: none"> LED20WWF 20W Equivalent LED Lamp, 2,700K, 60° 		
	<ul style="list-style-type: none"> LED35WFL 35W Equivalent LED Lamp, 2,700K, 35° 		
	<ul style="list-style-type: none"> LED35WWF 35W Equivalent LED Lamp, 2,700K, 60° 		

EXAMPLE FIXTURE CONFIGURATION:





LR-LED20WFL-LS-CU = LR-LED Lamp-Long Shroud-Copper Finish

* Ships with Super Slot Spike

Note: Beam Angle: FL = 35°, WF = 60° | Color Temperature: W = 2,700K

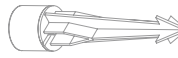
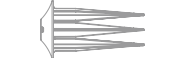

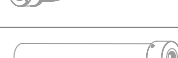
MOUNTING OPTIONS: Specify Separately





Mounts	Catalog No.	
<ul style="list-style-type: none"> LONG SLOT SPIKE 2.5" 6.3 cm x 10" 25.4 cm 	250015840000	
<ul style="list-style-type: none"> SUPER J-BOX 2.5" 6.3 cm x 12" 30.5 cm 	SJ-XX*	
<ul style="list-style-type: none"> 3-PRONG SPIKE 5.1" 6.3 cm x 9.0" 22.9 cm 	250020020000t	
<ul style="list-style-type: none"> PROAIM™ RATCHETING SPIKE 2.5" 6.3 cm x 10" 25.4 cm 	PARS	
<ul style="list-style-type: none"> POST MOUNT 2.5" 6.3 cm x 13" 33 cm 	PM-XX*	
<ul style="list-style-type: none"> VERSABOX 2.2" 5.7 cm x 1.5" 3.9 cm 	VB-050-XX*	

* YY = riser height in inches (6" increments between 6" and 36"),
XX = finish code

RISER OPTIONS: Specify Separately

Riser	Code	
<ul style="list-style-type: none"> RISER 0.8" 2.1 cm Diameter 	YY-R-GT-XX*	

LENS ACCESSORIES: Specify Separately

Item	Code	
<ul style="list-style-type: none"> RECESSOR RING MR-16 Size 	RRMR16	
<ul style="list-style-type: none"> HEX BAFFLE MR-16 Size 	250015260000	
<ul style="list-style-type: none"> FROSTED LENS MR-16 Size 	250015170000	
<ul style="list-style-type: none"> SOLITE SPREAD LENS MR-16 Size 	250015240000	

* YY = riser height in inches (6" increments between 6" and 36"),
XX = finish code

LR LED35W WF Illuminance at a Distance

Feet	Center Beam	Beam Width	
		Vertical 51.2°	Horizontal 49.9°
4.0 ft	24.1 fc	3.8 ft	3.7 ft
8.0 ft	6.03 fc	7.7 ft	7.4 ft
12.0 ft	2.68 fc	11.5 ft	11.2 ft
16.0 ft	1.51 fc	15.3 ft	14.9 ft
20.0 ft	0.96 fc	19.1 ft	18.6 ft
24.0 ft	0.67 fc	23.0 ft	22.3 ft

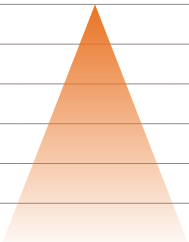

LR LED35W FL Illuminance at a Distance

Feet	Center Beam	Beam Width	
		Vertical 51.2°	Horizontal 49.9°
4.0 ft	24.1 fc	3.8 ft	3.7 ft
8.0 ft	6.03 fc	7.7 ft	7.4 ft
12.0 ft	2.68 fc	11.5 ft	11.2 ft
16.0 ft	1.51 fc	15.3 ft	14.9 ft
20.0 ft	0.96 fc	19.1 ft	18.6 ft
24.0 ft	0.67 fc	23.0 ft	22.3 ft

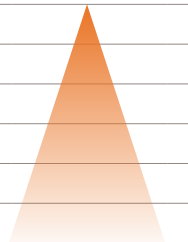

LR LED20W WF Illuminance at a Distance

Feet	Center Beam	Beam Width	
		Vertical 42.3°	Horizontal 41.5°
4.0 ft	21.6 fc	3.1 ft	3.0 ft
8.0 ft	5.39 fc	6.2 ft	6.1 ft
12.0 ft	2.40 fc	9.3 ft	9.1 ft
16.0 ft	1.35 fc	12.4 ft	12.1 ft
20.0 ft	0.86 fc	15.5 ft	15.2 ft
24.0 ft	0.60 fc	18.6 ft	18.2 ft

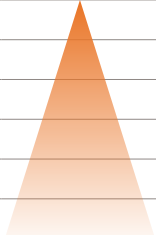

LR LED20W FL Illuminance at a Distance

Feet	Center Beam	Beam Width	
		Vertical 31.0°	Horizontal 31.0°
4.0 ft	38.7 fc	2.2 ft	2.2 ft
8.0 ft	9.69 fc	4.4 ft	4.4 ft
12.0 ft	4.30 fc	6.6 ft	6.7 ft
16.0 ft	2.42 fc	8.9 ft	8.9 ft
20.0 ft	1.55 fc	11.1 ft	11.1 ft
24.0 ft	1.08 fc	13.3 ft	13.3 ft

