

PRODUCT CATALOG

Landscape & Architectural Lighting

FXLuminaire®





TABLE

FX Luminaire

Advanced Outdoor Lighting Solutions	3
What's New at FX Luminaire	5
Designer Series and Standard Series	7
Lamps	125
Technical Data	131
Warranty	147
Education, Tools, and Support	143
CE Certified Lighting Products	146
Index	148

Lighting Control

Luxor® System	109
Luxor Controllers	113
Luxor Accessories	117
Transformers and Controllers	121



OF CONTENTS

Designer Series

Up Lights	13
Path and Area Lights	21
Wall Lights	31
Down Lights	39
Specialty Lights	49

Standard Series

Up Lights	55
Path and Area Lights	63
Wall Lights	75
Down Lights	81
Specialty Lights	87

Value Line

C-Line

Line-Voltage Series

Accessories

FX LUMINAIRE

Advanced Outdoor
Lighting Solutions



FX Luminaire provides industry-leading landscape and architectural lighting solutions for line- and low-voltage installations. We focus on the advancement of LED technology and digital lighting control with zoning, dimming, and color adjustment capabilities.

Our energy-efficient lighting fixtures are specially designed to create world-class lighting systems for a range of classic and contemporary applications.

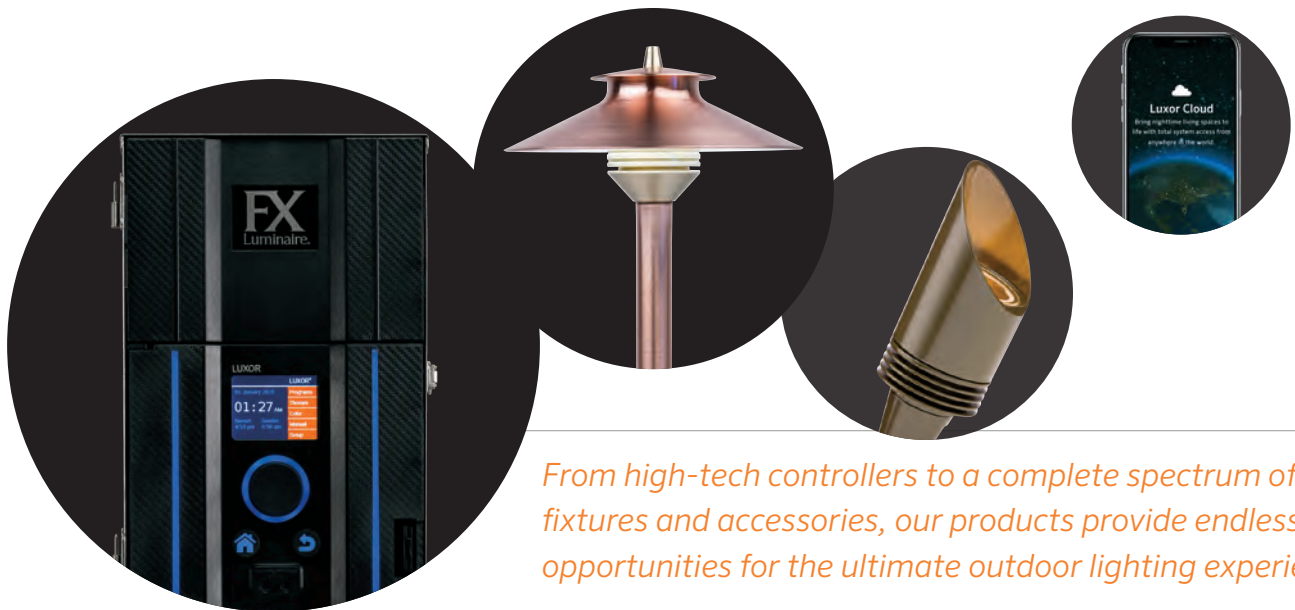

From high-tech controllers to a complete spectrum of fixtures and accessories, our products provide endless opportunities for the ultimate outdoor lighting experience.



WHAT'S NEW at FX Luminaire

To keep us at the forefront of outdoor lighting technology, we consistently strive to develop innovative solutions that push the boundaries of engineering.

When you choose FX Luminaire lighting products, you get more than timeless design and top-quality materials — you get the best technology and support the industry has to offer.

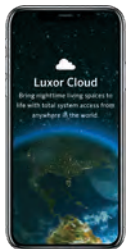

LUXOR CLOUD



LD LEDGE LIGHT



SRP STRIP LIGHT



NL-UD SCNCE



HS RECESSED
WALL LIGHT



MR-11/PAR-36
ECO LAMPS

Our most recent innovations include advanced cloud control, new hardscape lighting solutions, easy-to-install strip lighting, and high-efficiency LED replacement lamps.



Our convenient fixture classification system is based on material construction, performance, and price. This helps you quickly identify similar fixtures and create lighting systems for every project and budget. All FX Luminaire fixtures are made with top-quality materials and backed by the best customer and technical support in the industry.

Easily compare and choose fixtures that fit the control and environmental needs of your project.

DESIGNER SERIES & Standard Series



DESIGNER AND STANDARD LIGHTS

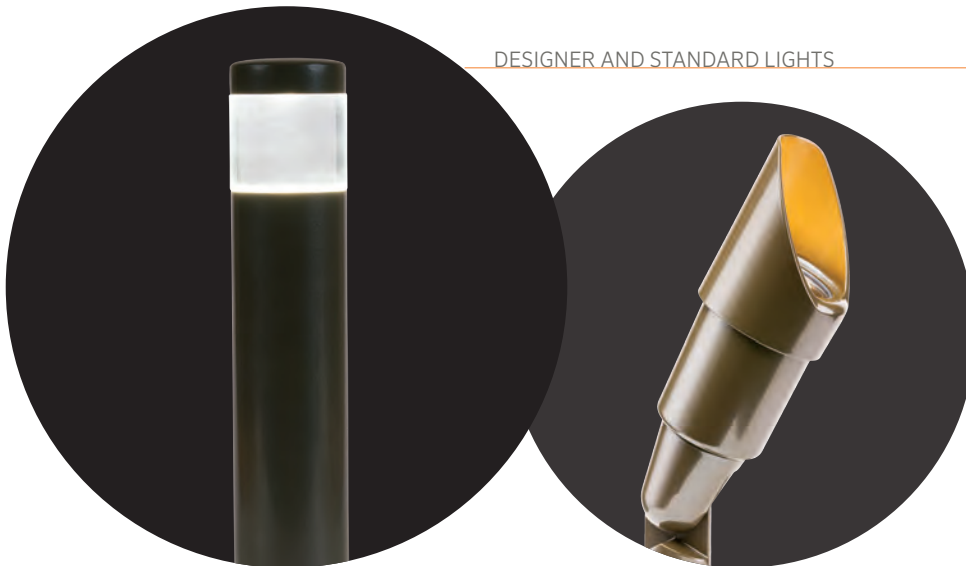

FX LUMINAIRE OFFERS
FIXTURES FOR EVERY
PROJECT AND BUDGET.

Find the Right Light for Every Project

DESIGNER SERIES

STANDARD SERIES

- Integrated LEDs
- Zoning, Dimming, and Color with Luxor Technology
- Premium Stainless Steel, Brass, or Copper

- LED Lamps
- Premium Copper or Brass

PREMIUM

PREMIUM

PLUS

PLUS

NP

RS

BASE

BASE

- Integrated LEDs
- Zoning, Dimming, and Color with Luxor Technology
- Aluminum

- LED Lamps
- Midgrade Brass or Aluminum

- Integrated LEDs
- Zoning and Dimming with Luxor Technology
- Aluminum or Composite

- LED Lamps
- Zinc, Aluminum, or Composite



Discover the Perfect Fixture



DESIGNER SERIES

Base	Plus	Premium
Popular FB, PL	Popular JB, LE, M-PL, NL, NP, PB, PM	Popular BQ, CC, DM, FR, KG, LC, LF, LP, PO-SQ, VE-PS
Additional Options KG-CB, QB, QT, QZ, TM	Additional Options DE, HP-48, LC, M-PJ, M-PK, M-PZ, MS, PS, RC, RW, SL, SD, VC, VE, ZC, ZW	Additional Options CP, DM, FC, KT, LE, LL, LM, NR, MO, NL, PB, PD, PS, VS, UN, VO, ZW, ZC,



STANDARD SERIES

Base	Plus	Premium
Popular LD, RS, SP-A, WS	Popular C-IN, C-LL, C-PL, C-UL, C-WW, MD, MM, MU, TM	Popular CA, CP, LO, LR, LS, MM, RL, TE, TS
Additional Options CF, DR, DS, FC, PD, RP, UN	Additional Options AL, CA-A, C-DL, C-WWL, DL-A, DM-A, MD, MP, PL, PM, RP, TS	Additional Options BP, CG, CL, CP, DL, DM, DP, FC, GN, LM, MR, PD, PF, RP, SC, SP, TC, TD/FG, UN, VL

FX Luminaire Designer Series

When you choose an FX Luminaire LED lighting system, you get the latest LED landscape lighting technology and digital lighting control with zoning, dimming, color temperature, and beam angle options.

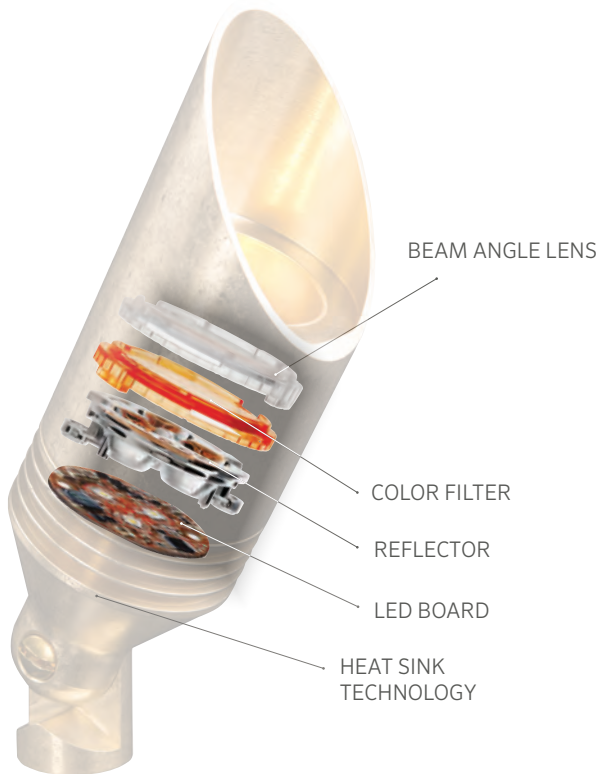

FX Luminaire LED Lighting Solutions

	Luxor Integrated System	Integrated System	Standard MR-16 System
	DESIGNER PREMIUM	DESIGNER PLUS	STANDARD
LED Warranty	10 years	10 years	5 years
Color	30,000+ Colors	4 Color Filters	Fixed
Beam Angle	Wide Flood	Interchangeable	Fixed
Control	Zoning, Dimming, and Color	Zoning and Dimming (Color Optional)	On/Off
Thermal Management	Global	Global	Local
Lamp Life	55,000 Hrs*	55,000 Hrs*	40,000 Hrs*

*Note: Useful LED life L90B10 (Avg.); Input voltage: 10 to 15 V.

What is the difference between using retrofit LED lamps and an integrated LED system?

Answer: An integrated LED fixture is engineered for optimum performance. These fixtures have a fully managed heat dissipation system. The focus on heat management reduces the threat of LED color shift and overheating. The built-in optics platform provides a simple configuration for adjusting color temperature and beam angle.

FX Luminaire LED systems give you total control over your lighting design. Control is the future of lighting. **When control, longevity, effects, and ease of installation are important factors, the Designer Series is the best option.**

Is the beam angle adjustable?

Answer: Yes, FX Luminaire integrated LEDs offer four beam angle options for maximum design flexibility. Adjust to your preference with very narrow, spot, flood, or wide flood lenses ranging from 10° to 60°. Similar to the color filters, these laser-cut lenses simply snap onto integrated LEDs.

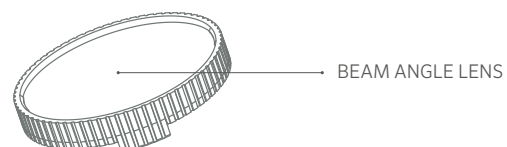

A modern outdoor landscape lighting fixture is the central focus, standing in a garden bed. The fixture has a dark, conical top with a glowing light source inside, and a slender, dark stem. The garden bed is filled with mulch, a large pink flower in the foreground, and various green plants and grasses. In the background, a house with a stone chimney and a window is visible, with another light fixture glowing nearby. The scene is set at dusk, with a soft blue sky and distant mountains.

When control, longevity, effects, and ease of installation are important factors, the Designer Series is the best option.

DESIGNER SERIES

Up Lights



Elegantly engineered for peak performance, FX Luminaire up lights convey intelligent design from the ground up. From wall washes to spots, we have the perfect fixture for every application.

Angled lenses effortlessly direct water away from the fixtures, while ProAim® Technology allows fixtures to be aimed in indexed increments for unmatched reliability.



SPOT LIGHT AND WALL WASH LIGHT



NP-3LED-BZ

Signifies products for quick delivery



Identifies UL rated products



Signifies CE or RCM certified products



GM-XX

Indicates requirements for CE certification



IP rating indicates water and dust resistance



Indicates certified wildlife-friendly products

FB DESIGNER PREMIUM



Fixture	Luxor + LED Configuration	Compliance	Shroud Option	Finish
FB [◊]	1LED Zone 60 Lumens* 2.0 W/2.4 VA	[blank] ½" Thread (UL)	[blank] 45° Angled Shroud	BZ DG WI FB SV FW*† SV*†
	3LED Zone 165 Lumens* 4.2 W/4.5 VA	e Bracket Mount (CE)		
	ZD3LED Zone/Dim 165 Lumens* 4.2 W/4.5 VA			

ORDERING EXAMPLE: ▶ FB-ZD3LED-BZ = FIXTURE-LUXOR/LED OPTION-FINISH

◊ Includes Super Slot Spike (753900)

Dimensions

Height: 8.1" (206 mm)
Diameter: 2.5" (64 mm)
Lead: 10' (3 m)
Material: Aluminum

ACCESSORIES: Specify Separately

Name	Code	Name	Code	Name	Code
Ground Mount	GM-XX**	Straight Coupling	COUP-XX**	Hex Baffle (MR-16)	250015260000
SJ-Box	SJ-XX**	90° Elbow Fitting	ELBW-050-XX**	Flood Lens	Δ-LEDFLENS
Straight Riser	YY-R-XX**	T-Mount Fitting	TMNT-050-XX**	Wide Flood Lens	Δ-LEDWFLENS



NP DESIGNER PLUS



Fixture	Luxor Option	LED Configuration	Compliance	Shroud Option	Finish
NP [◊]	[blank] Zone	3LED 135 Lumens* 4.2 W/4.5 VA	[blank] ½" Thread (UL)	[blank] 45° Angled Shroud	BZ DG WI SB FB FW*† SV*†
	ZD Zone/ Dim	6LED 279 Lumens* 8.2 W/9.7 VA	e Bracket Mount (CE)	LS 60° Angled Long Shroud	
		9LED 357 Lumens* 10.0 W/10.7 VA			
	ZDC[◊] Zone/ Dim/ Color	[blank] ZDC with 110 Lumens* 9.1 W/11.0 VA			

ORDERING EXAMPLE: ▶ NP-ZDC-BZ = FIXTURE-LUXOR OPTION-FINISH

◊ Includes Super Slot Spike (753900)

Dimensions

Height: 8.5" (216 mm)
Long Shroud: 10.4" (264 mm)
Diameter: 2.7" (69 mm)
Lead: 10' (3 m)
Material: Aluminum

ACCESSORIES: Specify Separately

Name	Code	Name	Code	Name	Code
Ground Mount	GM-XX**	Straight Coupling	COUP-XX**	Hex Baffle (MR-16)	250015260000
SJ-Box	SJ-XX**	90° Elbow Fitting	ELBW-050-XX**	Flood Lens	Δ-LEDFLENS
Straight Riser	YY-R-XX**	T-Mount Fitting	TMNT-050-XX**	Wide Flood Lens	Δ-LEDWFLENS



Powder Coat: Standard



Powder Coat: Specialty

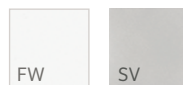

† Non-returnable ◊ Fixtures specified with ZDC Technology[®] are available only in one circuit board configuration. Do not specify a number of LEDs when ordering.
* May require longer lead time ** Finish code * Total delivered lumens

FR DESIGNER PREMIUM



Long Shroud

Fixture	Luxor + LED Configuration	Shroud Option	Finish
FR [◊]	1LED Zone 65 Lumens* 2.0 W/2.4 VA	LS 45° Angled Long Shroud	CU AB* AT* NP*
	3LED Zone 167 Lumens* 4.2 W/4.5 VA	[blank] 1.0" (25 mm) Straight Shroud	
	ZD3LED Zone/Dim 167 Lumens* 4.2 W/4.5 VA		
	ZDC* Zone/Dim/Color 113 Lumens* 6.0 W/7.2 VA		

ORDERING EXAMPLE: ▶ **FR-ZD3LED-BZ** = FIXTURE-LUXOR/LED OPTION-FINISH

[◊]Includes Long Slot Spike (250015840000)

ACCESSORIES: Specify Separately

Dimensions

Height: 6.1" (155 mm)
Long Shroud: 7.0" (178 mm)
Diameter: 2.0" (50 mm)
Lead: 10' (3 m)
Material: Copper/Brass

Name	Code	Name	Code	Name	Code
Post Mount	PM-XX**	Copper Riser with Fittings	YY-R-GT-XX**	Hex Baffle (MR-11)	250015250000
VersaBox	VB-050-XX**	Gutter Mount	GM-SS	Flood Lens	Δ-LEDFLENS
Ground Mount	GM-XX**	ProAim Ratcheting Spike	PARS	Wide Flood Lens	Δ-LEDWFLENS



NR DESIGNER PREMIUM



Long Shroud

Fixture	Luxor Option	LED Configuration	Shroud Option	Finish
NR [◊]	[blank] Zone	3LED 208 Lumens* 4.2 W/4.5 VA	LS 45° Angled Long Shroud	CU AB* AT* NP*
	ZD Zone/ Dim	6LED 397 Lumens* 8.2 W/9.7 VA	[blank] 1.5" (38 mm) Straight Shroud	
		9LED 430 Lumens* 10.0 W/10.7 VA		
	ZDC* Zone/ Dim/ Color	[blank] ZDC with 117 Lumens* 9.1 W/ 11.0 VA		

ORDERING EXAMPLE: ▶ **NR-ZD-3LED-LS-CU** = FIXTURE-LUXOR OPTION-LED-SHROUD OPTION-FINISH

[◊]Includes Long Slot Spike (250015840000)

ACCESSORIES: Specify Separately

Dimensions

Height: 6.1" (155 mm)
Long Shroud: 7.4" (188 mm)
Diameter: 2.5" (64 mm)
Lead: 10' (3 m)
Material: Copper/Brass

Name	Code	Name	Code	Name	Code
Post Mount	PM-XX**	Copper Riser with Fittings	YY-R-GT-XX**	Hex Baffle (MR-16)	250015260000
VersaBox	VB-050-XX**	Gutter Mount	GM-SS	Flood Lens	Δ-LEDFLENS
Ground Mount	GM-XX**	ProAim Ratcheting Spike	PARS	Wide Flood Lens	Δ-LEDWFLENS



Metal



† Non-returnable ◊ Fixtures specified with ZDC Technology® are available only in one circuit board configuration. Do not specify a number of LEDs when ordering.
* May require longer lead time ** Finish code * Total delivered lumens

CC DESIGNER PREMIUM



Long Shroud

Fixture	Luxor + LED Configuration	Shroud Option	Finish
CC ^o	1LED Zone 62 Lumens* 2.0 W/2.4 VA	LS 45° Angled Long Shroud	BS AB* AT* NP**
	3LED Zone 124 Lumens* 4.2 W/4.5 VA	[blank] 0.5" (13 mm) Straight Shroud	
	ZD3LED Zone/Dim 124 Lumens* 4.2 W/4.5 VA		
	ZDC* Zone/Dim/Color 109 Lumens* 6.0 W/7.2 VA		

ORDERING EXAMPLE: ▶ **CC-3LED-BZ** = FIXTURE-LUXOR/LED OPTION-FINISH

^o Includes Long Slot Spike (250015840000)

ACCESSORIES: Specify Separately

Dimensions

Height: 6.3" (160 mm)
Long Shroud: 7.2" (183 mm)
Diameter: 1.6" (41 mm)
Lead: 10' (3 m)
Material: Brass

Name	Code	Name	Code	Name	Code
Post Mount	PM-XX**	Copper Riser with Fittings	YY-R-GT-XX**	Hex Baffle (MR-11)	250015250000
VersaBox	VB-050-XX**	ProAim Ratcheting Spike	PARS	Flood Lens	Δ-LEDFLENS
SJ-Box	SJ-XX**	Three-Prong Spike	250020020000	Wide Flood Lens	Δ-LEDWFLENS
Ground Mount	GM-XX*				



VS DESIGNER PREMIUM



Long Shroud

Fixture	Luxor Option	LED Configuration	Shroud Option	Finish
VS ^o	[blank] Zone	3LED 159 Lumens* 4.2 W/4.5 VA	LS 45° Angled Long Shroud	BS AB* AT* NP**
	ZD Zone/Dim	6LED 300 Lumens* 8.2 W/9.7 VA	[blank] 1.0" (25 mm) Straight Shroud	
		9LED 360 Lumens* 10.0 W/10.7 VA		
	ZDC* Zone/Dim/Color	[blank] ZDC with 110 Lumens* 9.1 W/11.0 VA		

ORDERING EXAMPLE: ▶ **VS-ZDC-BS** = FIXTURE-LUXOR OPTION-FINISH

^o Includes Long Slot Spike (250015840000)

ACCESSORIES: Specify Separately

Dimensions

Height: 7.5" (191 mm)
Long Shroud: 8.2" (208 mm)
Diameter: 2.5" (64 mm)
Lead: 10' (3 m)
Material: Brass

Name	Code	Name	Code	Name	Code
Post Mount	PM-XX**	Copper Riser with Fittings	YY-R-GT-XX**	Hex Baffle (MR-16)	250015260000
VersaBox	VB-050-XX**	ProAim Ratcheting Spike	PARS	Flood Lens	Δ-LEDFLENS
SJ-Box	SJ-XX**	Three-Prong Spike	250020020000	Wide Flood Lens	Δ-LEDWFLENS
Ground Mount	GM-XX*	Junction Box Spike Kit	EKITSPIKE		



Metal



+ Non-returnable * Fixtures specified with ZDC Technology[®] are available only in one circuit board configuration. Do not specify a number of LEDs when ordering.
* May require longer lead time ** Finish code * Total delivered lumens

QZ DESIGNER BASE



Fixture	Luxor Option	LED Configuration	Shroud Option	Finish
QZ [◊]	[blank] Zone	1LED 62 Lumens 2.0 W/2.4 VA	[blank] 45° Angled Shroud	BZ DG WI SB FB FW** SV†
	ZD Zone/ Dim			

ORDERING EXAMPLE: ▶ QZ-ZD-1LED-BZ = FIXTURE-LUXOR OPTION-LED-FINISH

[◊] Includes Super Slot Spike (753900)

Dimensions

Height: 6.5" (166 mm)
Diameter: 1.7" (42 mm)
Lead: 10' (3 m)
Material: Aluminum

ACCESSORIES: Specify Separately

Name	Code	Name	Code	Name	Code
Mini J-Box	MJB-050-XX**	Straight Coupling	COUP-XX**	Hex Baffle (MR-11)	250015250000
SJ-Box	SJ-XX**	90° Elbow Fitting	ELBW-050-XX**	Flood Lens	1-LEDFLENS
Straight Riser	YY-R-XX**	T-Mount Fitting	TMNT-050-XX**	Wide Flood Lens	1-LEDWFLENS
Ground Mount	GM-XX**				



QB DESIGNER BASE



Fixture	Luxor Option	LED Configuration	Finish
QB [◊]	[blank] Zone	1LED 73 Lumens* 2.0 W/2.4 VA	BZ DG WI SB FB FW** SV**
	ZD Zone/Dim		

ORDERING EXAMPLE: ▶ QB-1LED-BZ = FIXTURE-LED-FINISH

[◊] Includes Super Slot Spike (753900)

Dimensions

Height: 5.0" (127 mm)
Width: 2.9" (75 mm)
Depth: 2.2" (55 mm)
Lead: 10' (3 m)
Material: Aluminum

ACCESSORIES: Specify Separately

Name	Code	Name	Code	Name	Code
Ground Mount	GM-XX**	Straight Coupling	COUP-XX**	Wall Plate, 1-Gang	WP-1G-050-XX**
Mini J-Box	MJB-050-XX**	90° Elbow Fitting	ELBW-050-XX**	Wall Plate, Round	WP-RD-050-XX**
SJ-Box	SJ-XX**	T-Mount Fitting	TMNT-050-XX**	Mini Mount	MM-050-XX**
Post Mount	PM-XX**	Straight Riser	YY-R-XX**	Variable Height Riser	VHR-UL



Powder Coat: Standard



Powder Coat: Specialty

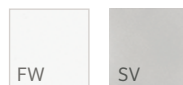

† Non-returnable [◊] Fixtures specified with ZDC Technology[®] are available only in one circuit board configuration. Do not specify a number of LEDs when ordering.
* May require longer lead time ** Finish code * Total delivered lumens

PB DESIGNER PLUS



Fixture	Luxor + LED Configuration	Compliance	Finish
PB [◊]	1LED Zone 67 Lumens* 2.0 W/2.4 VA	[blank] ½" Thread (UL)	BZ DG WI SB FB FW** SV** BS AB* AT* NP**
	3LED Zone 160 Lumens* 4.2 W/4.5 VA	e Bracket Mount (CE) (Powder Coat Finishes Only)	
	ZD3LED Zone/Dim 160 Lumens* 4.2 W/4.5 VA		
	ZDC[◊] Zone/Dim/Color 122 Lumens* 6.0 W/7.2 VA		

ORDERING EXAMPLE: ▶ PB-3LED-BZ = FIXTURE-LUXOR/LED OPTION-FINISH

[◊] Includes Super Slot Spike (753900)
ACCESSORIES: Specify Separately

Dimensions

Height: 6.0" (152 mm)
Width: 3.9" (98 mm)
Depth: 2.2" (56 mm)
Lead: 10' (3 m)
Material: Brass or Aluminum

Name	Code	Name	Code	Name	Code
Ground Mount	GM-XX**	Straight Coupling	COUP-XX**	Copper Riser with Fittings	YY-R-GT-XX**
SJ-Box	SJ-XX**	90° Elbow Fitting	ELBW-050-XX**	Wall Plate, 1-Gang	WP-1G-050-XX**
Aluminum Riser	YY-R-XX**	T-Mount Fitting	TMNT-050-XX**	Mini Mount	MM-050-XX**



LC DESIGNER PREMIUM



Fixture	Luxor Option	LED Configuration	Compliance	Finish
LC [◊]	[blank] Zone	3LED 154 Lumens* 4.2 W/4.5 VA	[blank] ½" Thread (UL)	BZ DG WI SB FB FW** SV** BS AB* AT* NP**
	ZD Zone/ Dim	6LED 331 Lumens* 8.2 W/9.7 VA	e Bracket Mount (CE) (Powder Coat Finishes Only)	
		9LED 436 Lumens* 10.0 W/10.7 VA		
	ZDC[◊] Zone/ Dim/ Color	[blank] ZDC with 192 Lumens* 9.1 W/ 11.0 VA		

ORDERING EXAMPLE: ▶ LC-ZDC-BZ = FIXTURE-LUXOR OPTION-FINISH

[◊] Includes Super Slot Spike (753900)

Dimensions

Height: 6.5" (165 mm)
Width: 4.5" (114 mm)
Depth: 3.0" (76 mm)
Lead: 10' (3 m)
Material: Brass or Aluminum

ACCESSORIES: Specify Separately

Name	Code	Name	Code	Name	Code
Ground Mount	GM-XX**	Mini Mount	MM-050-XX**	Copper Riser with Fittings	YY-R-GT-XX**
Straight Coupling	COUP-XX**	90° Elbow Fitting	ELBW-050-XX**	Wall Plate, 1-Gang	WP-1G-050-XX**
Aluminum Riser	YY-R-XX**	T-Mount Fitting	TMNT-050-XX**	Junction Box Spike Kit	EKITSPIKE



Powder Coat: Standard



Powder Coat: Specialty

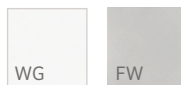

Metal



† Non-returnable ◊ Fixtures specified with ZDC Technology® are available only in one circuit board configuration. Do not specify a number of LEDs when ordering.
* May require longer lead time ** Finish code * Total delivered lumens

*Designer Series up lights are versatile,
durable, and easy to install.*





DESIGNER SERIES

Path and Area Lights

Targeted light delivery and elegant construction — combined with more finishes, height options, and control capabilities than any other brand — make FX Luminaire path lights second to none.

Whether you're looking to illuminate a walkway directly or deliver light to the surrounding landscape, our path lights give you unparalleled freedom to create the perfect setting.



AREA AND DIRECTIONAL PATH LIGHTS

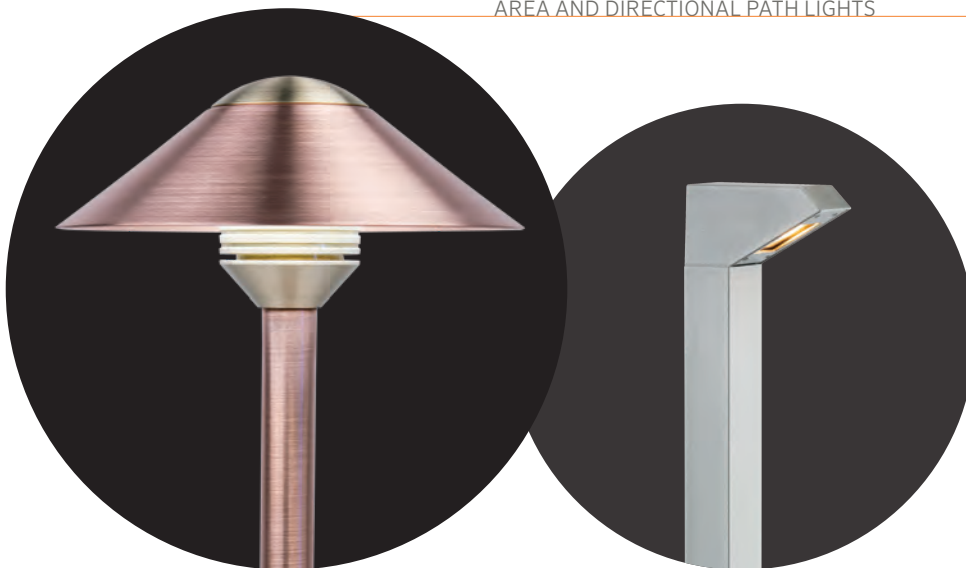

Signifies products available for quick delivery



Identifies UL rated products



Signifies CE or RCM certified products



Indicates requirements for CE certification



IP rating indicates water and dust resistance



Indicates certified wildlife-friendly products

Petite DESIGNER PREMIUM

DIMENSIONS
Overall Height:
14.5" (368 mm)[±]
Diameter: 3.6"
(92 mm)

HC



DIMENSIONS
Overall Height:
15.1" (384 mm)[±]
Diameter: 4.0"
(102 mm)

PF



DIMENSIONS
Overall Height:
14.7" (374 mm)[±]
Diameter: 3.8"
(97 mm)

SC



GENERAL Riser: ¾" Lead: 9' (2.7 m) Material: Copper/Brass

PATH LIGHT FINISH CHART

Component (Base Metal)	CU	Powder Coat	AB/AT	NP
Finial (Brass)	Natural Brass	Powder Coated	Antiqued	Nickel Plated
Top (Copper)	Natural Copper	Powder Coated	Antiqued	Nickel Plated
Reducer (Brass)	Natural Brass	Natural Brass	Antiqued	Nickel Plated
Riser (Copper)	Natural Copper	Powder Coated	Antiqued	Nickel Plated



TOP ASSEMBLY



RISER ASSEMBLY

Top Assembly	Top Finish	Riser Type	Luxor Option	LED Configuration	Riser Height	Finish
HCLEDTA PFLEDTA SCLEDTA	BZ DG WI SB FB FW** SV** CU AB* AT* NP**†	P [◊] (Petite)	[blank] Zone	1LED 19-39 Lumens* 2.0 W/2.4 VA	12RA 12" (300 mm)	BZ DG WI SB FB FW** SV** CU AB* AT* NP**†
		ZD	Zone/ Dim		18RA 18" (450 mm)	
					24RA* 24" (600 mm)	

ORDERING EXAMPLE: ▶ HCLEDTA-CU + P-ZD-1LED-18RA-CU = TOP ASSEMBLY-TOP FINISH + RISER TYPE- LUXOR OPTION-LED-RISER HEIGHT-FINISH

[◊]Includes Long Slot Spike (250015840000)

ACCESSORIES: Specify Separately

Name	Code	Name	Code	Name	Code
SJ-Box	SJ-XX**	VersaBox	VB-050-XX**	Ground Mount	GM-XX**
Post Mount	PM-XX**	ProAim Ratcheting Spike	PARS	Three-Prong Spike	250020020000



P-1LED-12RA-CU
HCLEDTA-CU

Powder Coat: Standard



Powder Coat: Specialty

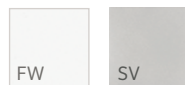

Metal



† Non-returnable ✦ Fixtures specified with ZDC Technology® are available only in one circuit board configuration. Do not specify a number of LEDs when ordering.
* May require longer lead time ** Finish code * Total delivered lumens * With 12" (300 mm) riser

Grande DESIGNER PREMIUM

DIMENSIONS
Overall Height:
15.6" (396 mm)[±]
Diameter: 6.3"
(159 mm)



JS

DIMENSIONS
Overall Height:
15.5" (394 mm)[±]
Diameter: 7.1"
(180 mm)



DM

DIMENSIONS
Overall Height:
15.5" (394 mm)[±]
Diameter: 7.4"
(188 mm)



CA

GENERAL Riser: ¾" Lead: 9' (2.7 m) Material: Copper/Brass

PATH LIGHT FINISH CHART

Component (Base Metal)	CU	Powder Coat	AB/AT	NP
Finial (Brass)	Natural Brass	Powder Coated	Antiqued	Nickel Plated
Top (Copper)	Natural Copper	Powder Coated	Antiqued	Nickel Plated
Reducer (Brass)	Natural Brass	Natural Brass	Antiqued	Nickel Plated
Riser (Copper)	Natural Copper	Powder Coated	Antiqued	Nickel Plated



TOP ASSEMBLY



RISER ASSEMBLY

Top Assembly	Top Finish	Riser Type	Luxor + LED Configuration	Riser Height	Finish
JSLEDTA DMLEDTA CALEDTA	BZ DG WI SB FB FW*† SV**† CU AB* AT* NP*†	G° (Grande)	1LED Zone 39 Lumens* 2.0 W/2.4 VA	12RA 12" (300 mm)	BZ DG WI SB FB FW*† SV**† CU AB* AT* NP*†
			3LED Zone 103 Lumens* 4.2 W/4.5 VA	18RA 18" (450 mm)	
			ZD3LED Zone/Dim 103 Lumens* 4.2 W/4.5 VA	24RA* 24" (600 mm)	
			ZDC* Zone/Dim/Color 73 Lumens* 6.0 W/7.2 VA		

ORDERING EXAMPLE: ▶ CALEDTA-CU + G-3LED-12RA-CU = TOP ASSEMBLY-TOP FINISH + RISER TYPE- LUXOR/LED-RISER HEIGHT-FINISH

° Includes Long Slot Spike (250015840000)

ACCESSORIES: Specify Separately

Name	Code	Name	Code	Name	Code
SJ-Box	SJ-XX**	VersaBox	VB-050-XX**	Three-Prong Spike	250020020000
Post Mount	PM-XX**	ProAim Ratcheting Spike	PARS	Ground Mount	GM-XX**



Powder Coat: Standard



Powder Coat: Specialty

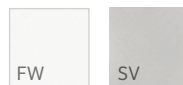

Metal



† Non-returnable * Fixtures specified with ZDC Technology® are available only in one circuit board configuration. Do not specify a number of LEDs when ordering.
* May require longer lead time ** Finish code * Total delivered lumens * With 12" (300 mm) riser

TM DESIGNER BASE

PL DESIGNER BASE



DIMENSIONS
 Height: 15.0" (381 mm)*
 Diameter: 5.0" (127 mm)

DIMENSIONS
 Height: 15.6" (396 mm)*
 Diameter: 6.0" (152 mm)

GENERAL
 Riser: 3/4"
 Lead: 9' (2.7 m)
 Material: Aluminum



Top Assembly	Top Finish	Riser Type	Luxor + LED Configuration	Riser Height	Finish
TMLEDTA PLLEDTA	BZ DG WI SB FB FW** SV**†	A° (Aluminum)	1LED Zone 39 Lumens* 2.0 W/2.4 VA	12RA 12" (300 mm)	BZ DG WI SB FB FW** SV**†
			3LED Zone 103 Lumens* 4.2 W/4.5 VA	18RA 18" (450 mm)	
			ZD3LED Zone/Dim 103 Lumens* 4.2 W/4.5 VA	24RA* 24" (600 mm)	
			ZDC* Zone/Dim/Color 73 Lumens* 6.0 W/7.2 VA		

ORDERING EXAMPLE: ▶ **PLLEDTA-BZ + A-3LED-12RA-BZ** = TOP ASSEMBLY-TOP FINISH + RISER TYPE-LUXOR/LED-RISER HEIGHT-FINISH

◊ Includes Long Slot Spike (250015840000)

ACCESSORIES: Specify Separately

Name	Code	Name	Code	Name	Code
SJ-Box	SJ-XX**	ProAim Ratcheting Spike	PARS	Ground Mount	GM-XX**
Post Mount	PM-XX**	Straight Coupling	COUP-XX**	Three-Prong Spike	250020020000
VersaBox	VB-050-XX**	Aluminum Riser	YY-R-XX**		



Powder Coat: Standard



Powder Coat: Specialty

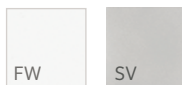

† Non-returnable ◊ Fixtures specified with ZDC Technology® are available only in one circuit board configuration. Do not specify a number of LEDs when ordering.
 * May require longer lead time ** Finish code * Total delivered lumens * With 12" (300 mm) riser

FG DESIGNER PREMIUM



Fixture	Luxor Option	LED Configuration	Finish
FG ^o	[blank] Zone	1LED 75 Lumens* 2.0 W/2.4 VA	BZ DG WI SB FB FW** SV** CU AB* AT* NP*
	ZD Zone/Dim	3LED 167 Lumens* 4.2 W/4.5 VA	
		6LED 374 Lumens* 8.2 W/9.7 VA	
		9LED 474 Lumens* 10.0 W/10.7 VA	
	ZDC ^o Zone/Dim/ Color	[blank] ZDC with 237 Lumens* 9.1 W/11.0 VA	

ORDERING EXAMPLE: ▶ FG-ZD-1LED-BZ = FIXTURE-LUXOR OPTION-LED-FINISH

^o Includes Long Slot Spike (250015840000)

Dimensions

Height: 18.0" (457 mm)
Diameter: 5.0" (127 mm)
Lead: 9' (2.7 m)
Material: Copper/Brass

ACCESSORIES: Specify Separately

Name	Code	Name	Code	Name	Code
SJ-Box	SJ-XX**	Copper Riser with Fittings	YY-R-GT-XX**	Three-Prong Spike	250020020000
Post Mount	PM-XX**	ProAim Ratcheting Spike	PARS		
VersaBox	VB-050-XX**	Ground Mount	GM-XX**		



TD DESIGNER PREMIUM



Fixture	Luxor Option	LED Configuration	Height Option	Finish
TD ^o	[blank] Zone	1LED 75 Lumens* 2.0 W/2.4 VA	[blank] Standard 18" (450 mm)	BZ DG WI SB FB FW** SV** CU AB* AT* NP**
	ZD Zone/ Dim	3LED 218 Lumens* 4.2 W/4.5 VA	XT Extra Tall 30" (750 mm)	
		6LED 404 Lumens* 8.2 W/9.7 VA		
		9LED 530 Lumens* 10.0 W/10.7 VA		
	ZDC ^o Zone/Dim/ Color	[blank] ZDC with 231 Lumens* 9.1 W/11.0 VA		

ORDERING EXAMPLE: ▶ TD-3LED-CU = FIXTURE-LED-HEIGHT-FINISH

^o Includes Long Slot Spike (250015840000)

Dimensions

Height: 16.2" (411 mm)
XT Height: 29.5" (749 mm)
Diameter: 5.0" (127 mm)
Lead: 9' (2.7 m)
Material: Copper/Brass

ACCESSORIES: Specify Separately

Name	Code	Name	Code	Name	Code
SJ-Box	SJ-XX**	Copper Riser with Fittings	YY-R-GT-XX**	Three-Prong Spike	250020020000
Post Mount	PM-XX**	ProAim Ratcheting Spike	PARS		
VersaBox	VB-050-XX**	Ground Mount	GM-XX**		



Powder Coat: Standard



Powder Coat: Specialty

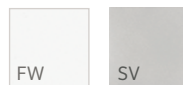

Metal



† Non-returnable ✦ Fixtures specified with ZDC Technology® are available only in one circuit board configuration. Do not specify a number of LEDs when ordering.
* May require longer lead time ** Finish code * Total delivered lumens

PM DESIGNER PLUS



Fixture	Luxor Option	LED Configuration	Compliance	Height Option	Finish
PM [◊]	[blank] Zone	1LED 41 Lumens* 2.0 W/2.4 VA	[blank] (UL)	[blank] Standard 14" (355 mm)	BZ DG WI SB FB
	ZD Zone/ Dim	3LED 106 Lumens* 4.2 W/4.5 VA	e (CE)	XT Extra Tall 18.5" (470 mm)	FW [†] SV
		6LED 186 Lumens* 8.2 W/9.7 VA			
		9LED 219 Lumens* 10.0 W/10.7 VA			
	ZDC [‡] Zone/ Dim/ Color	[blank] ZDC with 74 Lumens* 9.1W/11.0VA			

ORDERING EXAMPLE: ▶ **PM-ZD-3LED-XT-SV** = FIXTURE-LUXOR OPTION-LED-HEIGHT OPTION-FINISH

[◊] Includes Long Slot Spike (250015840000)

ACCESSORIES: Specify Separately

Dimensions

Height: 14.0" (356 mm)
 XT Height: 18.5" (470 mm)
 Diameter: 2.5" (64 mm)
 Lead: 9' (2.7 m)
 Material: Aluminum

Name	Code
Deck Mount	PDM-XX**



RW DESIGNER PLUS



Fixture	Luxor Option	LED Configuration	Riser Option	Finish
RW [◊]	[blank] Zone	3LED 168 Lumens* 4.2 W/4.5 VA	[blank] No Riser	BZ DG WI SB FB FW [†] SV [†]
	ZD Zone/Dim	6LED 460 Lumens* 8.2 W/9.7 VA	12R 12" (300 mm)	
		9LED 552 Lumens* 10.0 W/10.7 VA	18R 18" (450 mm)	
	ZDC [‡] Zone/Dim/ Color	[blank] ZDC with 188 Lumens* 9.1 W/11.0 VA	24R 24" (600 mm)	

ORDERING EXAMPLE: ▶ **RW-3LED-FB** = FIXTURE-LED-FINISH

[◊] Includes Long Slot Spike (250015840000)

ACCESSORIES: Specify Separately

Dimensions

Height: 14.0" (356 mm)^{*}
 Diameter: 3.9" (98 mm)
 Depth: 2.0" (50 mm)
 Lead: 9' (2.7 m)
 Material: Aluminum

Name	Code	Name	Code	Name	Code
Ground Mount	GM-XX**	Straight Coupling	COUP-XX**	Wall Plate, 1-Gang	WP-1G-050-XX**
Mini J-Box	MJB-050-XX**	90° Elbow Fitting	ELBW-050-XX**	Wall Plate, Round	WP-RD-050-XX**
SJ-Box	SJ-XX**	T-Mount Fitting	TMNT-050-XX**	Mini Mount	MM-050-XX**
Post Mount	PM-XX**	Straight Riser	YY-R-XX**	Variable Height Riser	VHR-UL



Powder Coat: Standard



Powder Coat: Specialty

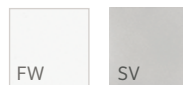

[†] Non-returnable [◊] Fixtures specified with ZDC Technology[®] are available only in one circuit board configuration. Do not specify a number of LEDs when ordering.
^{*} May require longer lead time ^{**} Finish code ^{*} Total delivered lumens ^{*} With 12" (300 mm) riser

M-PJ DESIGNER PLUS



Fixture	Luxor + LED Configuration	Compliance	Finish
M-PJ [◊]	1LED Zone 62 Lumens* 2.0 W/2.4 VA	[blank] (UL)	BZ DG WI SB FB FW** SV**
	3LED Zone 151 Lumens* 4.2 W/4.5 VA	e (CE)	
	6LED Zone 286 Lumens* 8.2 W/9.7 VA		
	ZD3LED Zone/Dim 151 Lumens* 4.2 W/4.5 VA		
	ZD6LED Zone/Dim 286 Lumens* 8.2 W/9.7 VA		
	ZDC[♣] Zone/Dim/Color 186 Lumens* 9.1 W/11.0 VA		

ORDERING EXAMPLE: ▶ M-PJ-3LED-FB = FIXTURE-LUXOR/LED OPTION-FINISH

[◊]Includes 30" (750 mm) length of 3/4" (19 mm) conduit

Dimensions
 Height: 22.1" (561 mm)
 Width: 2.8" (71 mm)
 Depth: 5.3" (135 mm)
 Lead: 9' (2.7 m)
 Material: Aluminum

ACCESSORIES: Specify Separately

Name	Code
Deck Mount	M-PJ-DM-XX**



M-PK DESIGNER PLUS



Fixture	Luxor + LED Configuration	Compliance	Finish
M-PK [◊]	1LED Zone 68 Lumens 2.0 W/2.4 VA	[blank] (UL)	BZ DG WI SB FB FW** SV**
	3LED Zone 152 Lumens 4.2 W/4.5 VA	e (CE)	
	ZD3LED Zone/Dim 152 Lumens 4.2 W/4.5 VA		
	ZDC[♣] Zone/Dim/Color 110 Lumens* 6.0 W/7.2 VA		

ORDERING EXAMPLE: ▶ M-PK-3LED-FB = FIXTURE-LUXOR/LED OPTION-FINISH

[◊]Includes 30" (750 mm) length of 1" (25 mm) conduit

Dimensions
 Height: 22.5" (572 mm)
 Width: 2.2" (56 mm)
 Depth: 4.7" (119 mm)
 Lead: 9' (2.7 m)
 Material: Aluminum

ACCESSORIES: Specify Separately

Name	Code
Deck Mount	M-PL-DM-XX**



Powder Coat: Standard



Powder Coat: Specialty



[†] Non-returnable [♣] Fixtures specified with ZDC Technology[®] are available only in one circuit board configuration. Do not specify a number of LEDs when ordering.
^{*} May require longer lead time ^{**} Finish code ^{*} Total delivered lumens

M-PZ DESIGNER PLUS



Fixture	Luxor + LED Configuration	Compliance	Finish
M-PZ ^o	1LED Zone 43 Lumens* 2.0 W/2.4 VA	[blank] (UL)	BZ DG WI SB FB FW* [†] SV* [†]
	3LED Zone 113 Lumens* 4.2 W/4.5 VA	e (CE)	
	ZD3LED Zone/Dim 113 Lumens* 4.2 W/4.5 VA		
	ZDC[‡] Zone/Dim/Color 60 Lumens* 6.0 W/7.2 VA		

ORDERING EXAMPLE: ▶ M-PL-ZDC-FB = FIXTURE-LUXOR OPTION-FINISH

^o Includes 30" (750 mm) length of 1" (25 mm) conduit

Dimensions

Height: 22.1" (561 mm)
Width: 2.5" (64 mm)
Depth: 2.5" (64 mm)
Lead: 9' (2.7 m)
Material: Aluminum

ACCESSORIES: Specify Separately

Name	Code
------	------

Deck Mount	M-PZ-DM-XX**
------------	--------------



M-PL DESIGNER PLUS



Fixture	Luxor Option	LED Configuration	Compliance	Finish
M-PL ^o	[blank] Zone	1LED 72 Lumens* 2.0 W/2.4 VA	[blank] (UL)	BZ DG WI SB FB FW* [†] SV* [†]
	ZD Zone/Dim		e (CE)	
	ZDC[‡] Zone/Dim/ Color	[blank] ZDC with 36 Lumens* 3.6 W/4.3 VA		

ORDERING EXAMPLE: ▶ M-PL-ZDC-FB = FIXTURE-LUXOR OPTION-FINISH

^o Includes 30" (750 mm) length of 1" (25 mm) conduit

Dimensions

Height: 21.3" (541 mm)
Width: 2.2" (55 mm)
Depth: 7.4" (187 mm)
Lead: 9' (2.7 m)
Material: Aluminum

ACCESSORIES: Specify Separately

Name	Code
------	------

Deck Mount	M-PL-DM-XX**
------------	--------------



Powder Coat: Standard



Powder Coat: Specialty

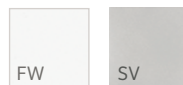

[†] Non-returnable [‡] Fixtures specified with ZDC Technology[®] are available only in one circuit board configuration. Do not specify a number of LEDs when ordering.
* May require longer lead time ** Finish code ^{*} Total delivered lumens

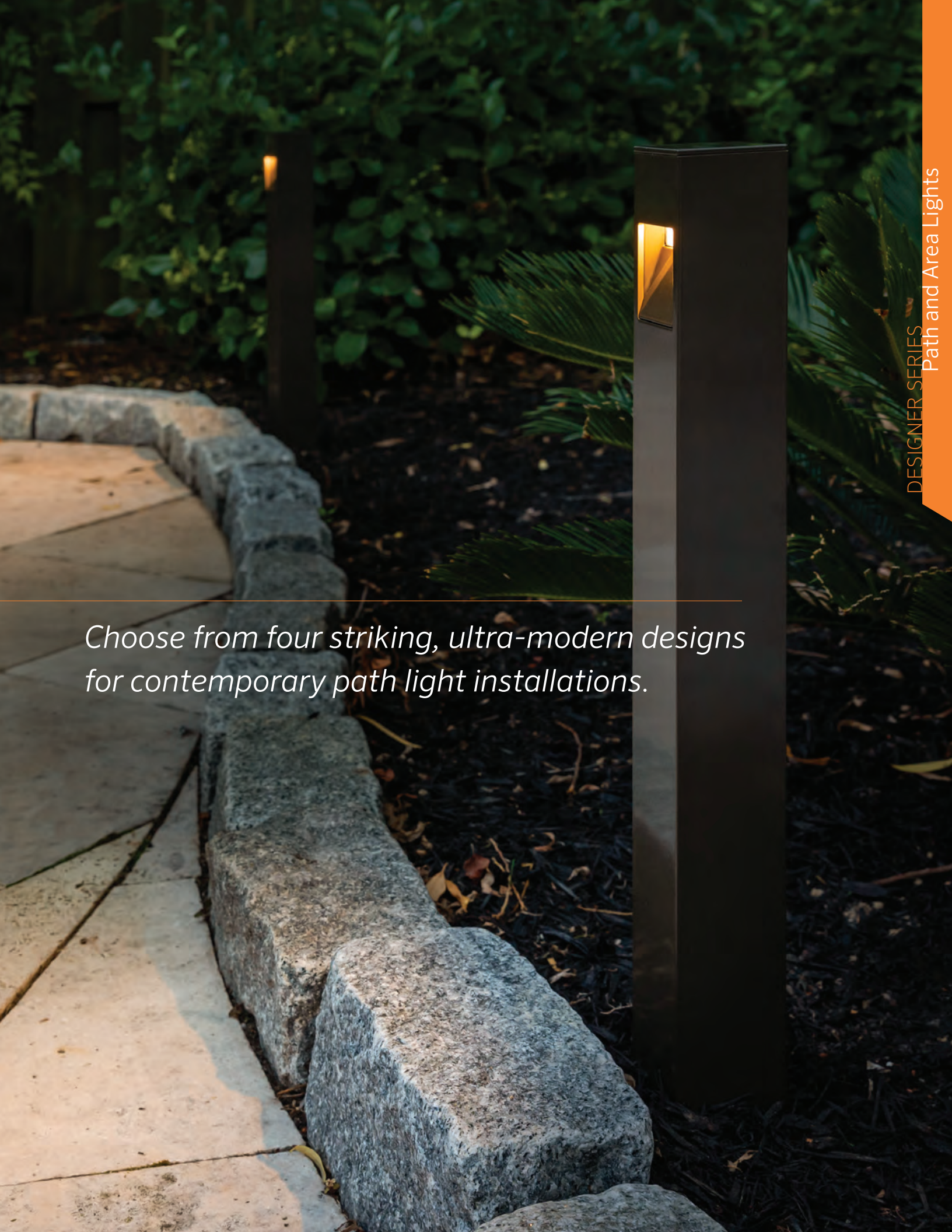

Choose from four striking, ultra-modern designs for contemporary path light installations.



DESIGNER SERIES

Wall Lights

Ideal for new or retrofit applications, FX Luminaire wall lights are available in a variety of recessed and surface-mounted options for maximum design flexibility.

Use wall lights to enhance outdoor living spaces, accent architectural features, and create safe walking paths.



RECESSED AND SURFACE-MOUNTED WALL LIGHTS

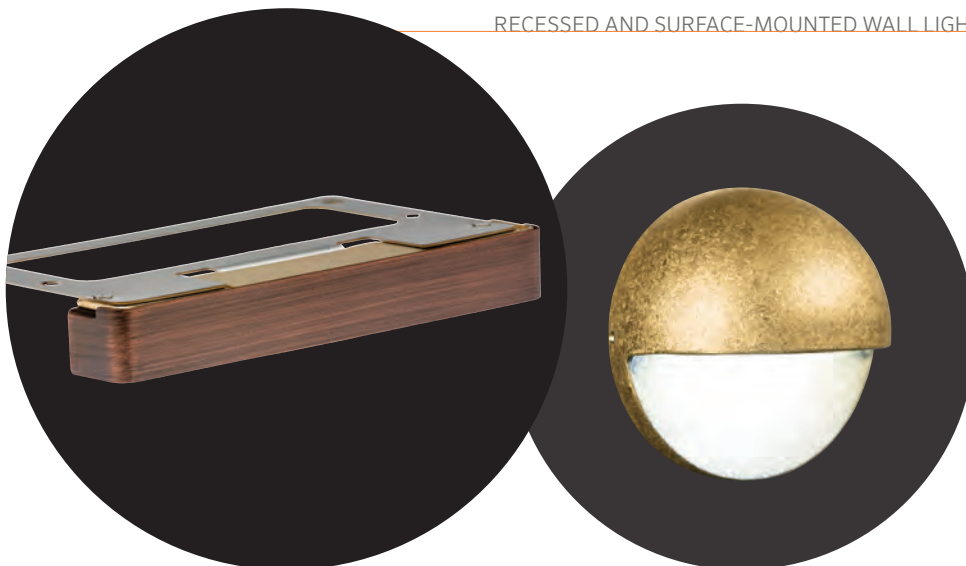

LF-1LED-W-BZ

Signifies products available for quick delivery



Identifies UL rated products



Signifies CE or RCM certified products



IP rating indicates water and dust resistance



Indicates certified wildlife-friendly products



Signifies ETL listed products



Signifies case quantity. We only ship in multiples of the number listed.

LF DESIGNER PREMIUM



Fixture	Luxor Option	LED Configuration	Color Temperature	Compliance	Finish
LF	[blank] Zone	1LED 75 Lumens* 2.0 W/2.4 VA	W Warm 2,700K	[blank] (UL)	BZ DG WI SB FB FW** SV** CU BS SS CU-AB* CU-AT* BS- AB* BS-AT*
	ZD Zone/ Dim		C Cool 3,900K	e (CE)	
	ZDC Zone/ Dim/ Color	[blank] 34 Lumens* 3.6 W/4.3 VA	[blank]		

ORDERING EXAMPLE: ▶ LF-ZD-1LED-W-BZ = FIXTURE-LUXOR OPTION-LED-COLOR TEMP-FINISH

◊ Includes Mounting Plate (755300)



Dimensions

Height: 0.9" (22 mm)
Length: 6.7" (170 mm)
Exposed Depth: 1.0" (25 mm)
Lead: 10' (3 m)
Material: Aluminum or Brass
Bracket: Stainless Steel

MS DESIGNER PLUS



Fixture	Luxor Option	LED Configuration	Compliance	Finish
MS	[blank] Zone	1LED 50 Lumens* 2.0 W/2.4 VA	[blank] (UL)	BZ DG WI SB FB FW** SV** BS AB* AT* NP**
	ZD Zone/Dim		e (CE)	

ORDERING EXAMPLE: ▶ MS-ZD-1LED-BS = FIXTURE-LUXOR OPTION-LED-FINISH



Dimensions

Diameter: 3.7" (93 mm)
Exposed Depth: 2.0" (51 mm)
Lead: 10' (3 m)
Material: Aluminum or Brass

Powder Coat: Standard



Powder Coat: Specialty

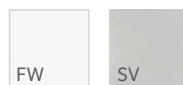

Metal: Copper



Metal: Brass



Metal



† Non-returnable ✦ Fixtures specified with ZDC Technology® are available only in one circuit board configuration. Do not specify a number of LEDs when ordering.
* May require longer lead time ** Finish code * Total delivered lumens

HS DESIGNER PLUS



Fixture	Luxor Option	LED Configuration	Color Temperature	Compliance	Finish
HS [◊]	[blank] Zone	2LED 100 Lumens* 3.5 W/3.8 VA	W Warm 2,700K	[blank] (UL)	BZ DG WI SB FB FW** SV**†
	ZD Zone/Dim		C Cool 3,900K	e (CE)	
	ZDC [◊] Zone/ Dim/Color	[blank] 165 Lumens* 8.1 W/8.6 VA	[blank]		

ORDERING EXAMPLE: ▶ HS-ZD-2LED-W-FB = FIXTURE-LUXOR OPTION-LED-FINISH

[◊]Includes Mounting Kit (MKHS)



Dimensions

Height: 2.3" (58 mm)
 Width: 8.0" (203 mm)
 Exposed Depth: 0.9" (23 mm)
 Lead: 10' (3 m)
 Material: Aluminum

Powder Coat: Standard



Powder Coat: Specialty

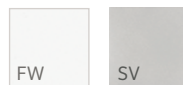

† Non-returnable ◊ Fixtures specified with ZDC Technology® are available only in one circuit board configuration. Do not specify a number of LEDs when ordering.
 * May require longer lead time ** Finish code * Total delivered lumens

LM DESIGNER PREMIUM

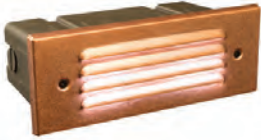

Fixture	Luxor Option	LED Configuration	Finish
LM ^o	[blank] Zone	2LED 14 Lumens* 4.0 W/4.8 VA	BZ DG WI FB SB FW** SV** CU AB* AT* NP**
	ZD Zone/Dim		

ORDERING EXAMPLE: ▶ LM-2LED-CU = FIXTURE-LED-FINISH

^o Includes Sleeve with Cover (250022030000)

Dimensions

Height: 3.5" (89 mm)
 Width: 9.1" (231 mm)
 Depth: 4.3" (109 mm)
 Exposed Depth: 0.5" (13 mm)
 Lead: 10' (3 m)
 Material: Copper

ACCESSORIES: Specify Separately

Name	Code
Wall Light Connection Kit	EKITWALL



CP DESIGNER PREMIUM



Fixture	Luxor Option	LED Configuration	Finish
CP ^o	[blank] Zone	1LED 4 Lumens* 2.0 W/2.4 VA	BZ DG WI FB SB FW** SV** CU AB* AT* NP**
	ZD Zone/Dim		

ORDERING EXAMPLE: ▶ CP-1LED-CU = FIXTURE-LED-FINISH

^o Includes Sleeve with Cover (250022040000)

Dimensions

Height: 3.5" (89 mm)
 Width: 5.0" (127 mm)
 Depth: 4.3" (109 mm)
 Exposed Depth: 0.5" (13 mm)
 Lead: 10' (3 m)
 Material: Copper

ACCESSORIES: Specify Separately

Name	Code
Wall Light Connection Kit	EKITWALL



Powder Coat: Standard



Powder Coat: Specialty

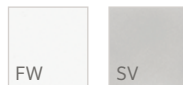

Metal



† Non-returnable ✦ Fixtures specified with ZDC Technology[®] are available only in one circuit board configuration. Do not specify a number of LEDs when ordering.
 * May require longer lead time ** Finish code * Total delivered lumens

PD DESIGNER PREMIUM



Fixture	Luxor Option	LED Configuration	Finish
PD [◊]	[blank] Zone	2LED 26 Lumens* 4.0 W/4.8 VA	BZ DG WI FB SB FW** SV** BS AB* AT* NP** CB DT
	ZD Zone/Dim		

ORDERING EXAMPLE: ▶ PD-2LED-CB = FIXTURE-LED-FINISH

◊ Includes Sleeve with Cover (250022030000)

Dimensions
 Height: 3.5" (89 mm)
 Width: 9.0" (229 mm)
 Depth: 4.4" (112 mm)
 Exposed Depth: 1.1" (28 mm)
 Lead: 10' (3 m)
 Material: Brass or Composite

ACCESSORIES: Specify Separately

Name	Code
Wall Light Connection Kit	EKITWALL



UN DESIGNER PREMIUM



Fixture	Luxor Option	LED Configuration	Finish
UN [◊]	[blank] Zone	1LED 11 Lumens* 2.0 W/2.4 VA	BZ DG WI FB SB SV FW** SV** BS AB* AT* NP** CB DT
	ZD Zone/Dim		

ORDERING EXAMPLE: ▶ UN-1LED-CB = FIXTURE-LED-FINISH

◊ Includes Sleeve with Cover (250022040000)

Dimensions
 Height: 3.6" (91 mm)
 Width: 5.2" (132 mm)
 Depth: 4.4" (112 mm)
 Exposed Depth: 1.1" (28 mm)
 Lead: 10' (3 m)
 Material: Brass or Composite

ACCESSORIES: Specify Separately

Name	Code
Wall Light Connection Kit	EKITWALL



Powder Coat: Standard



Powder Coat: Specialty

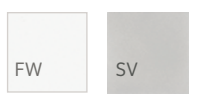

Composite



Metal: Brass

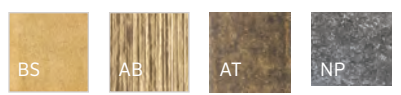

† Non-returnable ◊ Fixtures specified with ZDC Technology® are available only in one circuit board configuration. Do not specify a number of LEDs when ordering.
 * May require longer lead time ** Finish code * Total delivered lumens

PO DESIGNER PREMIUM



RD



SQ



ST



WW

Fixture	Luxor Option	LED Configuration	Faceplate Option	Finish
PO ^o	[blank] Zone	1LED 4-39 Lumens* 2.0 W/2.4 VA	RD Round	BZ DG WI FB SB FW** SV** BS AB* AT* NP**
	ZD Zone/Dim		SQ Square	
			ST Spot	
			WW Wall Wash	

ORDERING EXAMPLE: ▶ PO-1LED-ST-FB = FIXTURE-LED-FACEPLATE-FINISH

^oIncludes 1.5" Conduit Sleeve (250018590000)

Dimensions

Height: 2.5" (64 mm)
 Diameter: 1.5" (41 mm) conduit
 Lead: 10' (3 m)
 Material: Brass

ACCESSORIES: Specify Separately

Name	Code	Name	Code	Name	Code
PO Mounting Bracket	POBRKT	Standard Optics Kit	1LEDOPTICKIT	Wall Light Connection Kit	EKITWALL



VO DESIGNER PREMIUM



ST



In-Ground Mounting



RD



Conduit Sleeve

Fixture	Luxor Option	LED Configuration	Faceplate Option	Finish
VO ^o	ZD Zone/Dim	1LED 178 Lumens* 2.0 W/2.4 VA	ST Spot	SS
			RD Round	

ORDERING EXAMPLE: ▶ VO-ZD-1LED-ST-SS = FIXTURE-LUXOR-LED-FACEPLATE-FINISH

^oIncludes Conduit Sleeve

Dimensions

Height: 2.3" (58 mm)
 Diameter: 1.9" (48 mm)
 Lead: 10' (3 m)
 Material: Stainless Steel

ACCESSORIES: Specify Separately

Name	Code
VO, Ground Mount Kit	VOKITGRD



Powder Coat: Standard



Powder Coat: Specialty

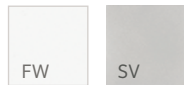

Metal

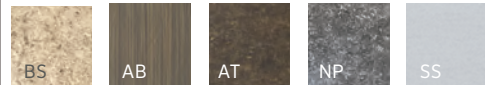

⁺ Non-returnable ^o Fixtures specified with ZDC Technology[®] are available only in one circuit board configuration. Do not specify a number of LEDs when ordering.
^{*} May require longer lead time ^{**} Finish code ^{*} Total delivered lumens

MO DESIGNER PREMIUM



Fixture	Luxor + LED Configuration		Faceplate Option		Finish
MO [◊]	1LED	Zone 13-68 Lumens 2.0 W/2.4 VA	RD	Round	BZ DG WI FB SB FW** SV** BS AB* AT* NP**
	3LED	Zone 33-169 Lumens 4.2 W/4.5 VA	SQ	Square	
	ZD3LED	Zone/Dim 33-169 Lumens 4.2 W/4.5 VA	ST	Spot	
	ZDC ⁺	Zone/Dim/Color 34 Lumens* 3.6 W/4.3 VA	WW	Wall Wash	

ORDERING EXAMPLE: ▶ MO-3LED-ST-FB = FIXTURE-LUXOR/LED-FACEPLATE-FINISH

◊ Includes 2.0" Conduit Sleeve (250020600000)

Dimensions

Height: 3.3" (84 mm)
Diameter: 2.0" (51 mm) conduit
Lead: 10' (3 m)
Material: Brass

ACCESSORIES: Specify Separately

Name	Code	Name	Code	Name	Code
MO Mounting Bracket	MOBRKT	Standard Optics Kit	ΔLEDOPTICKIT	Wall Light Connection Kit	EKITWALL



SL-3



SL-5

SL DESIGNER PLUS

Fixture	Luxor + LED Configuration		Color Temp		Faceplate Option		Finish
SL-3	1LED	Zone 48 Lumens 2.0 W/2.4 VA	W	2,700 K	BV ⁺	Bevel	BZ DG WI SB FB FW** SV** [†]
	3LED	Zone/Dim 78 Lumens 4.2 W/4.5 VA			RD ⁺	Round	
	ZD3LED	Zone/Dim 78 Lumens 4.2 W/4.5 VA			FT	Flat	
	ZDC ⁺	Zone/Dim/Color 60 Lumens* 6.0 W/7.2 VA	[blank]		CV	Curve	

ORDERING EXAMPLE: ▶ SL-3-3LED-BV-BZ = FIXTURE-LUXOR/LED-LED-FACEPLATE-FINISH

⁺ SL-3 only

Dimensions

Height: 4.9" (124 mm)
Depth: 2.1" (53 mm)
Width: 3.2" (81 mm)
Lead: 10' (3 m)
Material: Aluminum

ACCESSORIES: Specify Separately

Name	Code	Name	Code
1-Gang Junction Box, New Work	JB1GNWNM	Step-Down Transformer, 120 V to 12 V, 60 W	ST120DIM



Powder Coat: Standard



Powder Coat: Specialty

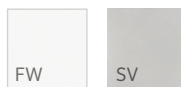

Metal



[†] Non-returnable [◊] Fixtures specified with ZDC Technology[®] are available only in one circuit board configuration. Do not specify a number of LEDs when ordering.
^{*} May require longer lead time ^{**} Finish code ^{*} Total delivered lumens



PENDANT AND DIRECTIONAL DOWN LIGHTS

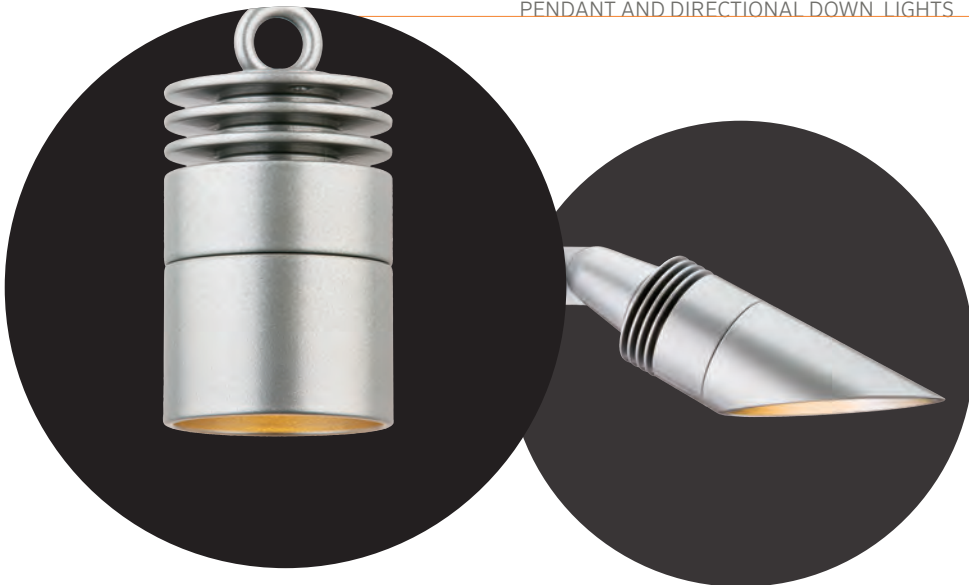

JB-3LED-BZ

Signifies products available for quick delivery



Identifies UL rated products



Signifies CE or RCM certified products



IP rating indicates water and dust resistance



Indicates certified wildlife-friendly products



Signifies ETL listed products



Signifies case quantity. We only ship in multiples of the number listed.



DESIGNER SERIES

Down Lights

Built with you in mind, FX Luminaire down lights offer unrivaled optical flexibility and limitless design potential. Use the fixtures to mimic the effects of natural moonlight in any outdoor installation.

Choose from classic or contemporary design elements and an array of junction boxes and wall plates to bring your vision to life.



ZW DESIGNER PLUS

Fixture	Luxor Option	LED Configuration	Direction	Finish
ZW ^o	ZD	Zone/Dim 1LED 48 Lumens* 2.0 W/2.4 VA	DN	Down Only BZ WI FB DG FW [†] SV ^{††} CU SS
		3LED 78 Lumens* 4.0 W/4.5 VA	UD	Up & Down
	ZDC [‡]	Zone/Dim/ Color [blank] 60 Lumens* 6.0 W/7.2 VA		

ORDERING EXAMPLE: ▶ ZW-ZD-3LED-DN-BZ = FIXTURE-LUXOR-LED-DIRECTION-FINISH

^o Includes Mounting Plate



Dimensions

Height: 3.9" (99 mm) to
10.3" (262 mm)
Diameter: 2.1" (53 mm) or
2.3" (58 mm)
Base Diameter: 4.7" (119 mm)
Lead: 10' (3 m)
Material: Aluminum,
Stainless Steel, or Copper



ZC DESIGNER PLUS

Fixture	Luxor Option	LED Configuration	Finish
ZC ^o	ZD	Zone/Dim 1LED 48 Lumens* 2.0 W/2.4 VA	BZ WI FB DG FW ^{††} SV ^{††} CU SS
		3LED 72 Lumens* 4.2 W/4.5 VA	
	ZDC [‡]	Zone/Dim/ Color [blank] 60 Lumens* 6.0 W/7.2 VA	

ORDERING EXAMPLE: ▶ ZC-ZD-3LED-FW = FIXTURE-LUXOR-LED-FINISH

^o Includes Mounting Plate



Dimensions

Height: 5.5" (140 mm)
Diameter: 2.1" (53 mm)
Base Diameter: 4.7" (119 mm)
Lead: 10' (3 m)
Material: Aluminum or Copper

Powder Coat: Standard



Powder Coat: Specialty

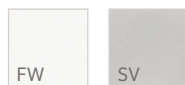

Metal



[†] Non-returnable [‡] Fixtures specified with ZDC Technology[®] are available only in one circuit board configuration. Do not specify a number of LEDs when ordering.
^{*} May require longer lead time ^{**} Finish code ^{*} Total delivered lumens

SD DESIGNER PLUS



Fixture	Luxor Option	LED Configuration	Finish
SD ^o	[blank] Zone	3LED 202 Lumens* 4.2 W/4.5 VA	BZ DG WI SB FB FW* [†] SV* [†]
	ZD Zone/Dim	6LED 367 Lumens* 8.2 W/9.7 VA	
		9LED 398 Lumens* 10.0 W/10.7 VA	
	ZDC ^o Zone/Dim/ Color	[blank] ZDC with 174 Lumens* 9.1 W/11.0 VA	

ORDERING EXAMPLE: ▶ SD-ZD-3LED-FB = FIXTURE-LUXOR OPTION-LED-FINISH

^oIncludes Mounting Plate (250027760000)

Dimensions

Height: 6.9" (175 mm)
Depth: 4.0" (102 mm)
Base Diameter: 5.3" (135 mm)
Lead: 10' (3 m)
Material: Aluminum

ACCESSORIES: Specify Separately

Name	Code	Name	Code
Solite Spread (MR-16)	250015240000	Flood Lens	Δ-LEDFLENS
Hex Baffle (MR-16)	250015260000	Wide Flood Lens	Δ-LEDWFLENS



RC DESIGNER PLUS



4" (102 mm) Retrofit Housing

Fixture	Luxor Option	LED Configuration	Finish
RC	[blank] Zone	3LED 261 Lumens* 4.2 W/4.5 VA	BZ DG WI SB FB FW* [†] SV* [†]
	ZD Zone/Dim	6LED 413 Lumens* 8.2 W/9.7 VA	
		9LED 722 Lumens* 10.0 W/10.7 VA	
	ZDC ^o Zone/Dim/ Color	[blank] 178 Lumens* 9.1 W/11.0 VA	

ORDERING EXAMPLE: ▶ RC-3LED-FW = FIXTURE-LED-FINISH

Dimensions

Height: 3.5" (89 mm)
Diameter: 5.5" (140 mm)
Exposed Depth: 0.1" (3 mm)
Lead: 10' (3 m)
Material: Aluminum

ACCESSORIES: Specify Separately

Name	Code	Name	Code	Name	Code
Hex Baffle (MR-16)	250015260000	Flood Lens	Δ-LEDFLENS	4" (102 mm) Retrofit Housing (Order in Quantities of 6)	CANR4RICAT
Solite Spread (MR-16)	250015240000	Wide Flood Lens	Δ-LEDWFLENS	Step-Down Transformer (12 V), Universal Input Voltage (120 V-233 V)	ST-UV
				Step-Down Transformer, Dimmable (120 V-12 V, 60 W)	ST-120-DIM



Powder Coat: Standard



Powder Coat: Specialty

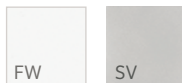

[†] Non-returnable ^o Fixtures specified with ZDC Technology[®] are available only in one circuit board configuration. Do not specify a number of LEDs when ordering.
^{*} May require longer lead time ^{**} Finish code ^{*} Total delivered lumens

QT DESIGNER BASE



Mini Mount

Fixture	Luxor Option	LED Configuration	Finish
QT [◊]	[blank] Zone	1LED 79 Lumens* 2.0 W/2.4 VA	BZ DG WI SB FB FW** SV**
	ZD Zone/Dim		

ORDERING EXAMPLE: ▶ QT-ZD-1LED-FB = FIXTURE-LUXOR OPTION-LED-FINISH

[◊]Includes Mini Mount (MM-050-XX)

Dimensions

Length: 6.8" (173 mm)
Diameter: 2.1" (53 mm)
Lead: 26' (8 m)
Material: Aluminum

ACCESSORIES: Specify Separately

Name	Code	Name	Code	Name	Code
Mini J-Box	MJB-050-XX**	Straight Riser Coupling	YY-R-COUP-XX**	Hex Baffle (MR-11)	250015250000
TreeBox	TB-XX**	90° Elbow Fitting	ELBW-050-XX**	Flood Lens	1-LEDFLENS
Wall Mount	WM-XX**	T-Mount Fitting	TMNT-050-XX**	Wide Flood Lens	1-LEDWFLENS



JB DESIGNER PLUS



e Version

Mini Mount

Fixture	Luxor + LED Configuration	Compliance	Shroud Options	Finish
JB	1LED Zone 73 Lumens	[blank] [◊] (UL) Mini Mount	[blank] 60° Angled	BZ DG WI SB FB FW** SV**
	3LED Zone 177 Lumens	e (CE) Bracket Mount	SS 3" (76 m) Straight	
	ZD3LED Zone/Dim 177 Lumens			
	ZDC [◊] Zone/Dim/Color 69 Lumens			

ORDERING EXAMPLE: ▶ JB-1LED-FB = FIXTURE-LED-FINISH

[◊]Includes Mini Mount (MM-050-XX)

Dimensions

Length: 10.4" (264 mm)
Diameter: 2.6" (66 mm)
Lead: 26' (8 m)
Material: Aluminum

ACCESSORIES: Specify Separately

Name	Code	Name	Code	Name	Code
TreeBox	TB-XX**	Wall Plate, 1-Gang	WP-1G-050-XX**	Straight Riser Coupling	YY-R-COUP-XX**
Mini J-Box	MJB-050-XX**	Wall Plate, Round	WP-RD-050-XX**	Flood Lens	Δ-LEDFLENS
90° Elbow Fitting	ELBW-050-XX**	Wall Mount	WM-XX**	Wide Flood Lens	Δ-LEDWFLENS
T-Mount Fitting	TMNT-050-XX**	Hex Baffle (MR-11)	250015250000	Solite Spread (MR-11)	250015420000



Powder Coat: Standard



Powder Coat: Specialty

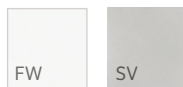

[†] Non-returnable [◊] Fixtures specified with ZDC Technology[®] are available only in one circuit board configuration. Do not specify a number of LEDs when ordering.
^{*} May require longer lead time ^{**} Finish code ^{*} Total delivered lumens

DE DESIGNER PLUS



Fixture	Luxor Option	LED Configuration	Compliance	Shroud Options	Finish
DE	[blank] Zone	3LED 162 Lumens* 4.2 W/4.5 VA	[blank] ^o Mini Mount	(UL) [blank] 60° Angled	BZ DG WI SB FB FW** SV**†
	ZD Zone/ Dim	6LED 328 Lumens* 8.2 W/9.7 VA	e Bracket Mount	(CE) SS 3" (76 m) Straight	
		9LED 344 Lumens* 10.0 W/10.7 VA			
	ZDC ^o Zone/ Dim/ Color	[blank] ZDC with 93 Lumens* 9.1 W/11.0 VA			

ORDERING EXAMPLE: ▶ DE-3LED-FB = FIXTURE-LED-FINISH

^o Includes Mini Mount (MM-050-XX)

Dimensions

Length: 11.7" (297 mm)
Diameter: 3.0" (76 mm)
Lead: 26' (8 m)
Material: Aluminum

ACCESSORIES: Specify Separately

Name	Code	Name	Code	Name	Code
TreeBox	TB-XX**	90° Elbow Fitting	ELBW-050-XX**	Hex Baffle (MR-11)	250015250000
Mini J-Box	MJB-050-XX**	T-Mount Fitting	TMNT-050-XX**	Hex Baffle (MR-16)	250015260000
Straight Coupling	COUP-XX**	Wall Plate, 1-Gang	WP-1G-050-XX**	Solite Spread (MR-11)	250015420000
Straight Riser	YY-R-XX**	Wall Plate, Round	WP-RD-050-XX**	Solite Spread (MR-16)	250015240000
Wall Mount	WM-XX**	Flood Lens	Δ-LEDFLENS	Wide Flood Lens	Δ-LEDWFLENS



Powder Coat: Standard



Powder Coat: Specialty

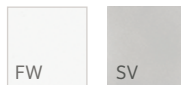

† Non-returnable ^o Fixtures specified with ZDC Technology[®] are available only in one circuit board configuration. Do not specify a number of LEDs when ordering.
* May require longer lead time ** Finish code * Total delivered lumens

LE DESIGNER PLUS



Fixture	Luxor Option	LED Configuration	Compliance	Finish
LE [◊]	[blank] Zone	1LED 44 Lumens* 2.0 W/2.4 VA	[blank] (UL)	BZ DG WI SB FB FW** SV** CU AB* AT* NP**
	ZD Zone/ Dim		e (CE)	

ORDERING EXAMPLE: ▶ LE-1LED-BZ = FIXTURE-LED-FINISH

◊ Includes Lock (2500182200000) and Cable (250021830000)



Dimensions

Height: 3.1" (79 mm)
 Diameter: 1.6" (41 mm)
 Lead: 26' (8 m)
 Material: Aluminum or
 Copper/Brass

VE DESIGNER PREMIUM



Fixture	Luxor + LED Configuration	Compliance	Sleeve Option	Finish
VE [◊]	1LED Zone 90 Lumens 2.0 W/2.4 VA	[blank] (UL)	[blank] Standard	BZ DG WI FB SB FW** SV** CU AB* AT* NP*
	3LED Zone 209 Lumens 4.2 W/4.5 VA	e (CE)	PS Perforated Sleeve	
	ZD3LED Zone/Dim 209 Lumens 4.2 W/4.5 VA			
	ZDC [†] Zone/Dim/Color 130 Lumens* 6.0 W/7.2 VA			

ORDERING EXAMPLE: ▶ VE-3LED-PS-CU = FIXTURE-LUXOR/LED OPTION-SLEEVE OPTION-FINISH

◊ Includes Lock (2500182200000) and Cable (250021830000)



Dimensions

Height: 4.3" (109 mm)
 Diameter: 2.3" (58 mm)
 Lead: 26' (8 m)
 Material: Aluminum or
 Copper

Powder Coat: Standard



Powder Coat: Specialty

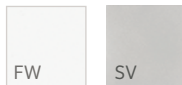

Metal: Copper



Metal: Copper/Brass



† Non-returnable ◊ Fixtures specified with ZDC Technology[®] are available only in one circuit board configuration. Do not specify a number of LEDs when ordering.
 * May require longer lead time ** Finish code * Total delivered lumens

PS DESIGNER PLUS



Fixture	Luxor Option	LED Configuration	Mount Option	Finish
PS	[blank] Zone	3LED 246 Lumens* 4.2 W/4.5 VA	[blank] ^o Standard Hardware	BZ DG WI FB SB BS BS-AB* BS-AT* NP** CU CU-AB* CU-AT*
	ZD Zone/Dim	6LED 395 Lumens* 8.2 W/9.7 VA	HB ^{oo} Hanging Bracket (Powder Coat Only)	
		9LED 570 Lumens* 10.0 W/10.7 VA		
	ZDC ⁺ Zone/Dim/Color	[blank] ZDC with 129 Lumens* 9.1 W/11.0 VA		

ORDERING EXAMPLE: ▶ PS-ZD-6LED-CU = FIXTURE-LUXOR OPTION-LED-FINISH

^oIncludes Housing Bracket (250016640000) and Mounting Bracket (250016650000)
^{oo}Includes Lock (250021820000) and Cable (250021830000)

Dimensions

Height: 4.2" (107 mm)
 Diameter: 3.0" (76 mm)
 Lead: 10' (3 m)
 Material: Brass or Aluminum

ACCESSORIES: Specify Separately

Name	Code	Name	Code	Name	Code
Wall Plate, PS	WP-RD-PS-XX	Flood Lens	Δ-LEDFLLENS	Hex Baffle (MR-16)	250015260000
CE Kit	WP-RD-PS-E-XX	Wide Flood Lens	Δ-LEDWFLLENS	Solite Spread (MR-16)	250015240000



NL DESIGNER PREMIUM

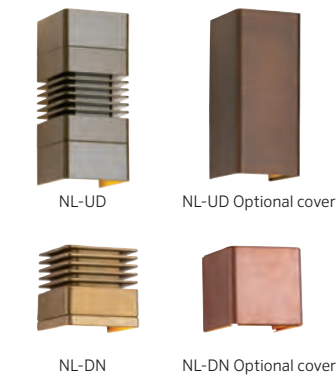

Fixture	Luxor Option	LED Configuration	Compliance	Direction	Cover	Finish
NL ^o	[blank] Zone	3LED 202 Lumens* 4.2 W/4.5 VA	[default] (UL)	DN Down	[default] Std Fins	BZ DG WI FB SB FW* ⁺ SV* ⁺ BS NP* ⁺ CU BS-AB* BS-AT* CU-AB* CU-AT*
	ZD Zone/Dim	6LED 367 Lumens* 8.2 W/9.7 VA	e (CE)	UD Up/Down	CR Cover	
		9LED 398 Lumens* 10.0 W/10.7 VA				
	ZDC ⁺ Zone/Dim/Color	[blank] 174 Lumens*				

ORDERING EXAMPLE: ▶ NL-3LED-UD-CR-CU = FIXTURE-LED-DIRECTION-COVER-FINISH

^oIncludes Housing Bracket (250016730000) and Mounting Bracket (250016740000)

Dimensions

DN Height: 3.1" (79 mm)
 DN Width: 3.2" (81 mm)
 DN Depth: 3.4" (86 mm)
 UD Height: 7.3" (185 mm)
 UD Width: 3.2" (81 mm)
 UD Depth: 3.3" (84 mm)
 Lead: 10' (3 m)
 Material: Brass or Aluminum

ACCESSORIES: Specify Separately

Name	Code	Name	Code	Name	Code
Wall Plate, NL	WP-2G-NL-XX	Flood Lens	Δ-LEDFLLENS	Hex Baffle (MR-16)	250015260000
CE Kit	WP-2G-NL-E-XX	Wide Flood Lens	Δ-LEDWFLLENS	Solite Spread (MR-16)	250015240000



Powder Coat: Standard



Powder Coat: Specialty

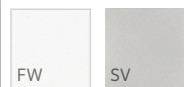

Metals

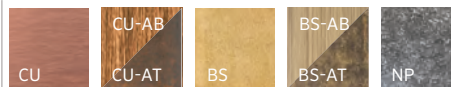

⁺ Non-returnable ^{*} Fixtures specified with ZDC Technology[®] are available only in one circuit board configuration. Do not specify a number of LEDs when ordering.
^{*} May require longer lead time ^{**} Finish code ^{*} Total delivered lumens

QL DESIGNER BASE



Fixture	Luxor Option	LED Configuration	Compliance	Finish
QL [◊]	[blank] Zone	1LED 53 Lumens*	[blank] (UL)	BZ DG WI SB FB FW** SV**
	ZD Zone/ Dim		e (CE)	

ORDERING EXAMPLE: ▶ QL-ZD-1LED-FB = FIXTURE-LED-FINISH

◊ Includes Mounting Bracket (250029320000)



QL-1LED-BZ
QL-1LED-FB

Dimensions

Height: 2.3" (58 mm)
Width: 1.5" (38 mm)
Depth: 2.2" (56 mm)
Lead: 10' (3 m)
Material: Aluminum



VC DESIGNER PLUS

Fixture	Luxor Option	LED Configuration	Finish
VC [◊]	ZD Zone/Dim	1LED 156 Lumens* 2.0 W/2.4 VA	FW

ORDERING EXAMPLE: ▶ VC-ZD-1LED-FW = FIXTURE-LUXOR-LED-FINISH

◊ Includes Mounting Bracket



VC-1LED-FW

Dimensions

Height: 3.3" (83 mm)
Diameter: 2.4" (62 mm)
Lead: 10' (3 m)
Material: Aluminum

Powder Coat: Standard



Powder Coat: Specialty

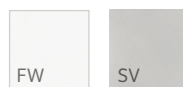

† Non-returnable ◊ Fixtures specified with ZDC Technology® are available only in one circuit board configuration. Do not specify a number of LEDs when ordering.
* May require longer lead time ** Finish code * Total delivered lumens

Down lights subtly enhance architecture while creating the illusion of additional space.





WELL LIGHTS AND UNDERWATER LIGHTS

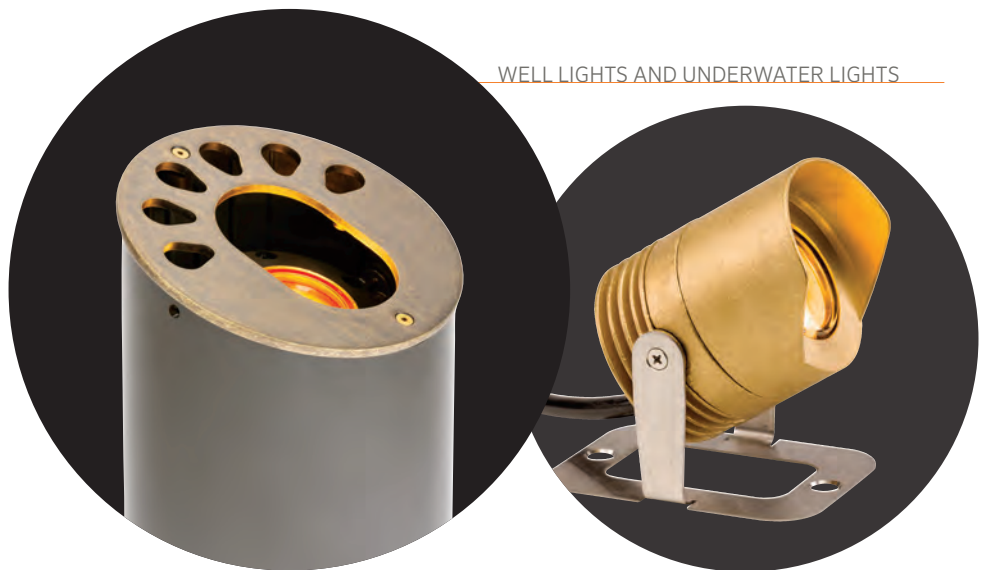



DESIGNER SERIES

Specialty Lights



Identifies UL rated products



Signifies CE or RCM certified products



Indicates requirements for CE certification



IP rating indicates water and dust resistance



Indicates certified wildlife-friendly products

Engineered to provide versatile, high-efficiency solutions for niche applications and specialized effects, specialty lights open a range of new opportunities for creative lighting design.

From water features and sculptures to boulders and barbecues, statement pieces are meant to shine. Choose the specialty light that's right for you.

KG DESIGNER PREMIUM

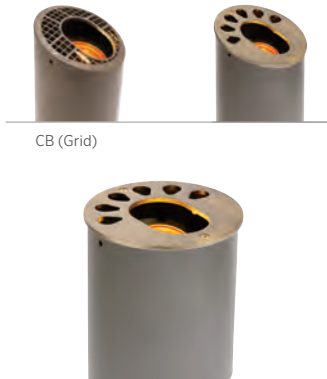

CB (Grid)

Fixture	Luxor Option	LED Configuration	Compliance	Finish
KG [◊]	[blank] Zone	3LED 127 Lumens* 4.2 W/4.5 VA	[blank] (UL)	BZ DG WI FB SB FW** SV** BS AB* AT* NP**
	ZD Zone/ Dim	6LED 265 Lumens* 8.2 W/9.7 VA	e (CE)	CB (Grid)
		9LED 322 Lumens* 10.0 W/10.7 VA		
	ZDC [◊] Zone/ Dim/ Color	[blank] ZDC with 123 Lumens* 9.1 W/11.0 VA		

ORDERING EXAMPLE: ▶ **KG-9LED-BS** = FIXTURE-LED-FINISH

[◊] Includes 6.0" (152 mm) Reversible (Flat/Angled) Conduit Sleeve (250011630000)

Dimensions

Height: 9.2" (234 mm)
Diameter: 6.1" (155 mm)
Lead: 10' (3 m)
Material: Brass, Aluminum,
or Composite



FC DESIGNER PREMIUM



Ring (RG)

Cowling (CW)

Wash (GW)

Louver (LV)

Fixture	Luxor Option	LED Configuration	Compliance	Style Option	Finish
FC [◊]	[blank] Zone	3LED 83-185 Lumens* 4.2 W/4.5 VA	[blank] (UL)	RG Ring	BZ DG WI FB
	ZD Zone/ Dim	6LED 123-334 Lumens* 8.2 W/9.7 VA	e (CE)	LV Louver	SB FW** SV** BS AB* AT*
		9LED 170-419 Lumens* 10.0 W/10.7 VA		CW Cowling	NP**
	ZDC [◊] Zone/ Dim/ Color	[blank] ZDC with 216 Lumens* 9.1 W/ 11.0 VA		GW-90 Ground Wash 90°	
				GW-180 Ground Wash 180°	
				GW-270 Ground Wash 270°	
				GW-360 Ground Wash 360°	

ORDERING EXAMPLE: ▶ **FC-9LED-LV-BS** = FIXTURE-LED-STYLE OPTION-FINISH

[◊] Includes Construction Sleeve (250014260000)

Dimensions

Height: 4.8" (122mm)
Diameter: 4.0" (102 mm)
Lead: 10' (3 m)
Material: Brass



Powder Coat: Standard



Powder Coat: Specialty

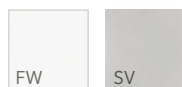

Metal: Brass

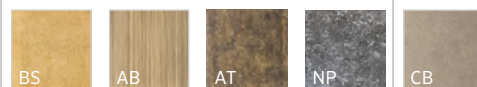

Composite

† Non-returnable [◊] Fixtures specified with ZDC Technology[®] are available only in one circuit board configuration. Do not specify a number of LEDs when ordering.
* May require longer lead time ** Finish code * Total delivered lumens

HP-48 DESIGNER PLUS



Fixture	Size	Luxor Option	LED Configuration	Color Temp.	Compliance	Finish
HP ^o	48 4" x 8" (102 mm x 203 mm)	ZD Zone/ Dim	1LED 17 Lumens* 2.0 W/2.4 VA	W Warm (2,700K)	[blank] (UL)	DS
				C Cool (3,900K)	e (CE)	
		ZDC ^o Zone/ Dim/ Color	[blank] ZDC with 28 Lumens* 3.6 W/4.3 VA	[blank]		

ORDERING EXAMPLE: ▶ HP48-1LED-W-DS = FIXTURE-LUXOR-LED-FINISH

^oIncludes Mounting Kit (MKHP48)



Dimensions

Height: 3.1" (79 mm)
Width: 4.0" (102 mm)
Length: 8.0" (203 mm)
Lead: 10' (3 m)
Material: Composite

KT DESIGNER PREMIUM



Fixture	Luxor Option	LED Configuration	Finish
KT ^o	[Default] Zone	3LED 127 Lumens* 4.2 W/4.5 VA	BZ DG WI FB SB FW ^{††} SV ^{††} SS
	ZD Zone/Dim		
	ZDC ^o Zone/Dim/Color	[blank] ZDC with 168 Lumens* 6.0 W/7.2 VA	

ORDERING EXAMPLE: ▶ KT-ZD-3LED-SS = FIXTURE-LUXOR-LED-FINISH

^oIncludes Mounting Kit (MKKT)



Dimensions

Height: 9.4" (240 mm)
Diameter: 7.0" (178 mm)
Lead: 10' (3 m)
Material: Stainless Steel

BQ DESIGNER PREMIUM



Fixture	Luxor Option	LED Configuration	Finish
BQ	ZD Zone/Dim	1LED 82 Lumens* 2.0 W/2.4 VA	SS

ORDERING EXAMPLE: ▶ BQ-ZD-1LED-SS = FIXTURE-LUXOR-LED-FINISH

Dimensions

Arm Length: 24.0" (610 mm)
Base Diameter: 3.6" (91 mm)
Head Diameter: 1.8" (46 mm)
Lead: 10' (3 m)
Material: Stainless Steel

ACCESSORIES: Specify Separately

Name	Code
Mini Transformer, 6 W	MT6W



Powder Coat: Standard



Powder Coat: Specialty

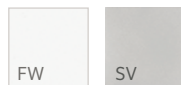

Metal: Composite



[†] Non-returnable ^o Fixtures specified with ZDC Technology[®] are available only in one circuit board configuration. Do not specify a number of LEDs when ordering.
^{*} May require longer lead time ^{**} Finish code ^{*} Total delivered lumens

LP DESIGNER PREMIUM

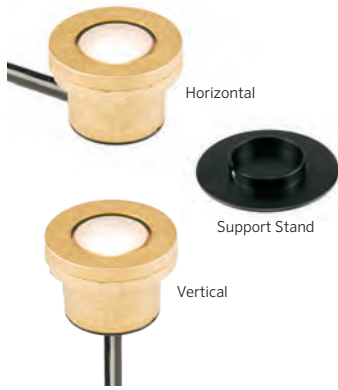

Fixture	Luxor + LED Configuration	Compliance	Wire Direction	Wire Length	Finish
LP	1LED Zone 74 Lumens* 2.0 W/2.4 VA	[blank] (UL)	HZ ^o Horizontal with Support Stand	30 30' (9 m) Lead	BS
	3LED Zone 173 Lumens* 4.2 W/4.5 VA	e (CE)	VR Vertical for Conduit	XL 100' (30 m) Lead	
	ZD3LED Zone/Dim 173 Lumens* 4.2 W/4.5 VA				
	ZDC ⁺ Zone/Dim/Color 147 Lumens* 6.0 W/7.2 VA				

ORDERING EXAMPLE: ▶ LP-1LED-VR-XL-BS = FIXTURE-LUXOR/LED-WIRE DIRECTION-WIRE LENGTH-FINISH

^oIncludes Support Stand (250022480000)



Dimensions

Height: 1.9" (48 mm)
Diameter: 2.7" (69 mm)
Support Stand Diameter:
4.0" (102 mm)
Material: Brass

LL DESIGNER PREMIUM



Fixture	Luxor Option	LED Configuration	Compliance	Finish	Wire Length
LL ^o	[blank] Zone	3LED 127 Lumens* 4.2 W/4.5 VA	[blank] (UL)	BS	[blank] 30' (9 m) Lead
	ZD Zone/Dim	6LED 265 Lumens* 8.2 W/9.7 VA	e (CE)		XL 100' (30 m) Lead
		9LED 322 Lumens* 10.0 W/10.7 VA			
	ZDC ⁺ Zone/Dim/Color	[blank] ZDC with 123 Lumens* 9.1 W/11.0 VA			

ORDERING EXAMPLE: ▶ LL-ZDC-BS = FIXTURE-LED-FINISH

^oIncludes Stainless Steel Stand (250025480000)



Dimensions

Length: 4.0" (102 mm)
Diameter: 3.2" (81 mm)
Material: Brass

Metal



† Non-returnable ^o Fixtures specified with ZDC Technology[®] are available only in one circuit board configuration. Do not specify a number of LEDs when ordering.
* May require longer lead time ** Finish code * Total delivered lumens



Underwater fixtures bring the cascading streams and rocky crags of outdoor water features to life.



SPOT LIGHT AND WALL WASH

STANDARD SERIES

Up Lights



Use the warmth of up lights to accent foliage, create visual interest, and highlight stonework or other architectural features.

Choose from powder-coated, brass, or copper finishes depending on environmental needs.



RS-LED20WFL-BZ

Signifies products available for quick delivery



Identifies UL rated products



Signifies CE or RCM certified products



IP rating indicates water and dust resistance



Indicates minimum quantity

RS STANDARD

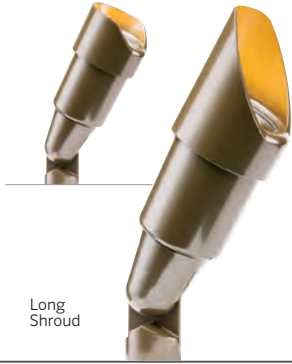

Long Shroud

Fixture	Lamp	Shroud Option	Finish
RS ^o	LED20WFL 261 Lumen Lamp 4.0 W/4.3 VA	[blank] 15° Angled Shroud	BZ DG WI SB FB
	LED35WFL 337 Lumen Lamp 5.0 W/5.4 VA	LS 45° Angled Long Shroud	
	LED50WFL 447 Lumen Lamp 6.0 W/6.5 VA		
	ZD35WFL 337 Lumen Lamp 5.0 W/5.4 VA Zone/Dim with Luxor [®]		
	NL No Lamp		

ORDERING EXAMPLE: ▶ **RS-LED20WFL-LS-BZ** = FIXTURE-LAMP-SHROUD-FINISH

^oIncludes Super Slot Spike (753900)

Dimensions

Height: 6.6" (168 mm)
Long Shroud: 7.8" (198 mm)
Diameter: 2.5" (64 mm)
Lamp: MR-16
Lead: 10' (3 m)
Material: Zinc/Aluminum

ACCESSORIES: Specify Separately

Name	Code	Name	Code	Name	Code
Ground Mount	GM-XX**	Straight Coupling	COUP-XX**	Hex Baffle (MR-16)	250015260000
SJ-Box	SJ-XX**	90° Elbow Fitting	ELBW-050-XX**	Frosted Lens (MR-16)	250015170000
Straight Riser	YY-R-XX**	T-Mount Fitting	TMNT-050-XX**	Solite Spread (MR-16)	250015240000



RS-LED20WFL-BZ
RS-NL-BZ



MP STANDARD PLUS



Fixture	Lamp	Finish
MP ^o	ECO20WFL 138 Lumens* 2.0 W/3.3 VA	BZ DG WI FB SB FW** SV**
	ECO20SFL 138 Lumens* 2.0 W/3.3 VA	
	NL No Lamp	

ORDERING EXAMPLE: ▶ **MP-ECO20SFL-DG** = FIXTURE-LAMP-FINISH

^oIncludes Super Slot Spike (753900)

Dimensions

Height: 6.5" (166 mm)
Diameter: 1.7" (42 mm)
Lamp: MR-11
Lead: 10' (3 m)
Material: Zinc/Aluminum

ACCESSORIES: Specify Separately

Name	Code	Name	Code	Name	Code
Mini J-Box	MJB-050-XX**	Straight Coupling	COUP-XX**	Hex Baffle (MR-11)	250015250000
VersaBox	VB-050-XX**	90° Elbow Fitting	ELBW-050-XX**	Solite Spread (MR-11)	250015420000
SJ-Box	SJ-XX**	T-Mount Fitting	TMNT-050-XX**	Frosted Lens (MR-11)	250010480000
Post Mount	PM-XX**	Straight Riser	YY-R-XX**	Mini Mount	MM-050-XX



Powder Coat: Standard



Powder Coat: Specialty

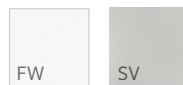

† Non-returnable * May require longer lead time ** Finish code * Total delivered lumens

MU STANDARD PLUS



e Version

Fixture	Lamp	Compliance	Shroud	Finish
MU ^o	LED20WFL 261 Lumen Lamp 4.0 W/4.3 VA	[blank] ½" Thread (UL)	LS 45° Angled Long Shroud	BZ DG WI
	LED35WFL 337 Lumen Lamp 5.0 W/5.4 VA	e (CE)		FB SB FW*† SV*†
	LED50WFL 447 Lumen Lamp 6.0 W/6.5 VA			
	ZD35WFL 337 Lumen Lamp 5.0 W/5.4 VA Zone/Dim with Luxor [®]			
	NL No Lamp			

ORDERING EXAMPLE: ▶ **MU-LED20WFL-LS-BZ** = FIXTURE-LAMP-SHROUD-FINISH

^oIncludes Super Slot Spike (753900)

ACCESSORIES: Specify Separately

Dimensions

Height: 8.7" (221 mm)
Diameter: 2.2" (56 mm)
Lamp: MR-16
Lead: 10' (3 m)
Material: Aluminum

Name	Code	Name	Code	Name	Code
Mini J-Box	MJB-050-XX**	Straight Coupling	COUP-XX**	Solite Spread (MR-16)	250015240000
VersaBox	VB-050-XX**	90° EWWWow Fitting	ELBW-050-XX**	Frosted Lens (MR-16)	250015170000
SJ-Box	SJ-XX**	T-Mount Fitting	TMNT-050-XX**	RecessorRing (MR-16)	RRMR16
Post Mount	PM-XX**	Straight Riser	YY-R-XX**	ProAim Ratcheting Spike	PARS



MU-NL-LS-BZ
MU-LED20WFL-LS-BZ

LO STANDARD PREMIUM



Long Shroud

Fixture	Lamp	Shroud Option	Finish
LO ^o	LED20WFL 261 Lumen Lamp 4.0 W/4.3 VA	[blank] Straight Cut Shroud	BS NP**
	LED35WFL 337 Lumen Lamp 5.0 W/5.4 VA	LS 45° Angled Long Shroud	
	LED50WFL 447 Lumen Lamp 6.0 W/6.5 VA		
	ZD35WFL 337 Lumen Lamp 5.0 W/5.4 VA Zone/Dim with Luxor [®]		
	NL No Lamp		

ORDERING EXAMPLE: ▶ **LO-ZD35WFL-BS** = FIXTURE-LAMP-FINISH

^oIncludes Super Slot Spike (753900)

ACCESSORIES: Specify Separately

Dimensions

Height: 8.4" (213 mm)
Diameter: 2.3" (57 mm)
Lamp: MR-16
Lead: 10' (3 m)
Material: Brass

Name	Code	Name	Code	Name	Code
Post Mount	PM-XX**	Copper Riser with Fittings	YY-R-GT-XX**	RecessorRing (MR-16)	RRMR16
VersaBox	VB-050-XX**	Hex Baffle (MR-16)	250015260000	ProAim Ratcheting Spike	PARS
Ground Mount	GM-XX**	Solite Spread (MR-16)	250015240000	Gutter Mount	GM-SS



Powder Coat: Standard



Powder Coat: Specialty

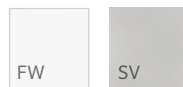

Metal



† Non-returnable

* May require longer lead time ** Finish code

MR STANDARD PREMIUM



Long Shroud

Fixture	Lamp	Shroud Option	Finish
MR	ECO20WFL 118 Lumens* 2.0 W/3.3 VA	[blank] 1" (25 mm) Straight Shroud	CU NP**
	ECO20SFL 118 Lumens* 2.0 W/3.3 VA	LS 45° Angled Long Shroud	
	NL No Lamp		

ORDERING EXAMPLE: ▶ MR-NL-LS-CU = FIXTURE-LAMP-SHROUD-FINISH

◊ Includes Super Slot Spike (753900)

Dimensions

Height: 7.4" (188 mm)
 Diameter: 2.2" (56 mm)
 Lamp: MR-11
 Lead: 10' (3 m)
 Material: Copper/Brass

ACCESSORIES: Specify Separately

Name	Code	Name	Code	Name	Code
Post Mount	PM-XX**	Copper Riser with Fittings	YY-R-GT-XX**	ProAim Ratcheting Spike	PARS
VersaBox	VB-050-XX**	Gutter Mount	GM-SS	Solite Spread (MR-11)	250015420000
SJ-Box	SJ-XX**	Hex Baffle (MR-11)	250015250000	Frosted Lens (MR-11)	250010480000



LR STANDARD PREMIUM



Long Shroud

Fixture	Lamp	Shroud Option	Finish
LR [◊]	LED20WFL 261 Lumen Lamp 4.0 W/4.3 VA	[blank] 1.5" (38 mm) Straight Shroud	CU NP**
	LED35WFL 337 Lumen Lamp 5.0 W/5.4 VA	LS 45° Angled Long Shroud	
	LED50WFL 447 Lumen Lamp 6.0 W/6.5 VA		
	ZD35WFL 337 Lumen Lamp 5.0 W/5.4 VA Zone/Dim with Luxor®		
	NL No Lamp		

ORDERING EXAMPLE: ▶ LR-LED20WFL-CU = FIXTURE-LAMP-FINISH

◊ Includes Super Slot Spike (753900)

Dimensions

Height: 8.3" (211 mm)
 Diameter: 2.5" (64 mm)
 Lamp: MR-16
 Lead: 10' (3 m)
 Material: Copper/Brass

ACCESSORIES: Specify Separately

Name	Code	Name	Code	Name	Code
Post Mount	PM-XX**	Copper Riser with Fittings	YY-R-GT-XX**	ProAim Ratcheting Spike	PARS
VersaBox	VB-050-XX**	Gutter Mount	GM-SS	Solite Spread (MR-16)	250015240000
Ground Mount	GM-XX**	Hex Baffle (MR-16)	250015260000	Frosted Lens (MR-16)	250015170000



Metal



+ Non-returnable * May require longer lead time ** Finish code * Total delivered lumens



C-UL STANDARD PLUS

Fixture	Lamp	Shroud	Finish
C-UL [◊]	LED20WFL 180 Lumens* 4.0 W/4.3 VA	AS Adjustable Shroud	AB
	LED35WFL 250 Lumens* 5.0 W/5.4 VA		
	NL No Lamp		

ORDERING EXAMPLE: ▶ **C-UL-LED20WFL-AS-AB** = FIXTURE-LAMP-SHROUD-FINISH

◊ Includes Long Slot Spike (250015840000)

Dimensions

Height: 6.5" (165 mm)
 Diameter: 2.4" (61 mm)
 Lamp: MR-16
 Lead: 10' (3 m)
 Material: Brass

ACCESSORIES: Specify Separately

Name	Code	Name	Code	Name	Code
Mini J-Box	MJB-050-XX**	Post Mount	PM-XX**	ProAim Ratcheting Spike	PARS
VersaBox	VB-050-XX**	Solite Spread (MR-16)	250015240000	Copper Riser with Fittings	YY-R-GT-XX**
SJ-Box	SJ-XX**	Frosted Lens (MR-16)	250015170000	Gutter Mount	GM-SS



C-UL-LED20WFL-AS-AB

Metal



+ Non-returnable * May require longer lead time ** Finish code * Total delivered lumens



C-WW STANDARD PLUS

Fixture	Lamp		Finish
C-WW ^o	LED35W	170 Lumen Lamp 2.4 W/2.6 VA	AB

ORDERING EXAMPLE: ▶ C-WW-LED35W-AB = FIXTURE-LAMP-FINISH

^o Includes Long Slot Spike (250015840000)

Dimensions

Height: 6.5" (165 mm)
Width: 4.0" (102 mm)
Lamp: G4
Lead: 10' (3 m)
Material: Brass

ACCESSORIES: Specify Separately

Name	Code	Name	Code	Name	Code
Post Mount	PM-XX**	SJ-Box	SJ-XX**	Copper Riser with Fittings	YY-R-GT-XX**
VersaBox	VB-050-XX**	Gutter Mount	GM-SS	ProAim Ratcheting Spike	PARS



C-WW-LED35W-AB



C-WW-LED35W-AB



C-WWL STANDARD PLUS

Fixture	Lamp		Finish
C-WWL ^o	LED35WFL	183 Lumens* 5.0 W/5.4 VA	AB
	LED50WFL	218 Lumens* 6.0 W/6.5 VA	

ORDERING EXAMPLE: ▶ C-WWL-LED50WFL-AB = FIXTURE-LAMP-FINISH

^o Includes Long Slot Spike (250015840000)

Dimensions

Height: 6.5" (165 mm)
Width: 5.4" (137 mm)
Lamp: MR-16
Lead: 10' (3 m)
Material: Brass



C-WWL-LED35WFL-AB
C-WWL-LED50WFL-AB



C-WWL-LED35WFL-AB

Metal



+ Non-returnable * May require longer lead time ** Finish code * Total delivered lumens



WS STANDARD

Fixture	Lamp	Finish
WS ^o	LED35W 170 Lumen Lamp 2.4 W/2.6 VA	BZ DG WI FB SB FW [†] SV [†]

ORDERING EXAMPLE: ▶ WS-LED35W-SV = FIXTURE-LAMP-FINISH

^o Includes Super Slot Spike (753900)

Dimensions

Height: 6.4" (163 mm)
Width: 4.0" (102 mm)
Lamp: G4
Lead: 10' (3 m)
Material: Aluminum

ACCESSORIES: Specify Separately

Name	Code	Name	Code	Name	Code
Mini J-Box	MJB-050-XX**	Straight Coupling	COUP-XX**	Post Mount	PM-XX**
VersaBox	VB-050-XX**	90° Elbow Fitting	ELBW-050-XX**	Straight Riser	YY-R-XX**
SJ-Box	SJ-XX**	T-Mount Fitting	TMNT-050-XX**	Mini Mount	MM-050-XX



WS-LED35W-BZ



WS-LED35W-BZ



RL STANDARD PREMIUM

Fixture	Lamp	Finish
RL ^o	LED20W 123 Lumen Lamp 1.1 W/1.7 VA	BZ DG WI FB SB FW [†] SV [†] CU NP [†]
	LED35W 170 Lumen Lamp 2.4 W/2.6 VA	
	NL No Lamp	

ORDERING EXAMPLE: ▶ RL-LED20W-CU = FIXTURE-LAMP-FINISH

^o Includes Super Slot Spike (753900)

Dimensions

Height: 6.0" (153 mm)
Diameter: 4.0" (102 mm)
Lamp: G4
Lead: 10' (3 m)
Material: Copper/Brass

ACCESSORIES: Specify Separately

Name	Code	Name	Code	Name	Code
Post Mount	PM-XX**	SJ-Box	SJ-XX**	Copper Riser with Fittings	YY-R-GT-XX**
VersaBox	VB-050-XX**	Gutter Mount	GM-SS	ProAim Ratcheting Spike	PARS



Powder Coat: Standard



Powder Coat: Specialty

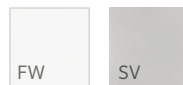

Metal



[†] Non-returnable

* May require longer lead time ** Finish code * Total delivered lumens



Use path lights to softly illuminate walkways, create ambience, increase safety, and highlight landscape features along the way.

Choose from a variety of elegant styles in metal and powder-coat finishes to complement an array of outdoor living spaces.

STANDARD SERIES

Path and Area Lights



MODERN AND TRADITIONAL LIGHTS



SPA-LED20W-12R-BZ

Signifies products available for quick delivery



Identifies UL rated products



Signifies CE or RCM certified products



IP rating indicates water and dust resistance



Indicates minimum quantity

SP STANDARD PREMIUM



Fixture	Lamp	Riser Height	Finish
SP ^o	LED20W 123 Lumen Lamp 1.6 W/1.7 VA	12R 12" (300 mm)	BZ DG WI FB SB FW[†] SV[†] CU NP[†]
	NL No Lamp	18R 18" (450 mm) 24R 24" (600 mm)	AB* AT* (no lamp, 12/18" option only)

ORDERING EXAMPLE: ▶ **SP-LED20W-12R-CU** = FIXTURE-LAMP-RISER-FINISH

^o Includes Super Slot Spike (753900)

ACCESSORIES: Specify Separately

Dimensions

Height: 14.5" (368 mm)*
Diameter: 3.6" (91 mm)
Riser Diameter: 3/4"
Lamp: G4
Lead: 9' (2.7 m)
Material: Copper/Brass

Name	Code	Name	Code	Name	Code
SJ-Box	SJ-XX**	Ground Mount	GM-XX**	ProAim Ratcheting Spike	PARS
Post Mount	PM-XX**	Three-Prong Spike	250020020000	Copper Riser with Fittings	YY-R-GT-XX**
VersaBox	VB-050-XX**				



DL STANDARD PREMIUM



Fixture	Lamp	Riser Height	Finish
DL ^o	LED20W 123 Lumen Lamp 1.6 W/1.7 VA	12R 12" (300 mm)	BZ DG WI FB SB FW[†] SV[†] CU NP[†]
	NL No Lamp	18R 18" (450 mm) 24R 24" (600 mm)	AB* AT* (no lamp, 12/18" option only)

ORDERING EXAMPLE: ▶ **DL-LED20W-18R-CU** = FIXTURE-LAMP-RISER-FINISH

^o Includes Super Slot Spike (753900)

ACCESSORIES: Specify Separately

Dimensions

Height: 15.6" (396 mm)*
Diameter: 6.3" (160 mm)
Riser Diameter: 3/4"
Lamp: G4
Lead: 9' (2.7 m)
Material: Copper/Brass

Name	Code	Name	Code	Name	Code
SJ-Box	SJ-XX**	Ground Mount	GM-XX**	ProAim Ratcheting Spike	PARS
Post Mount	PM-XX**	Three-Prong Spike	250020020000		
VersaBox	VB-050-XX**	Copper Riser with Fittings	YY-R-GT-XX**		



Powder Coat: Standard



Powder Coat: Specialty

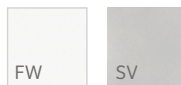

Metal:



[†] Non-returnable

* May require longer lead time ** Finish code ± With 12" (300 mm) riser

Petite STANDARD PREMIUM

DIMENSIONS
Overall Height:
15.1" (384 mm)[†]
Diameter: 5.1"
(130 mm)



PF

DIMENSIONS
Overall Height:
15.0" (381 mm)[†]
Diameter: 4.7"
(119 mm)

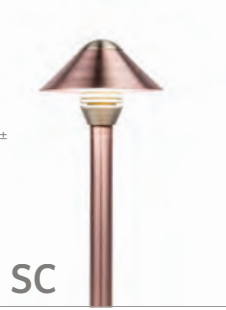

SC

Grande STANDARD PREMIUM

DIMENSIONS
Overall Height:
15.5" (394 mm)[†]
Diameter: 7.1"
(180 mm)

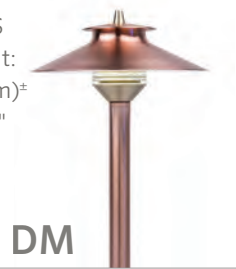

DM

DIMENSIONS
Overall Height:
15.4" (391 mm)[†]
Diameter: 7.6"
(193 mm)



CA

GENERAL Riser: 3/4" Lamp: G4 Lead: 9' (2.7 m) Material: Copper/Brass

Fixture	Lamp	Riser Height	Finish
PF [◊] SC [◊] DM ^{◊◊} CA ^{◊◊}	LED20W 123 Lumen Lamp 1.6 W/1.7 VA	12R 12" (300 mm)	BZ DG WI SB FB FW** SV** CU NP** Additional finishes for DM: AB* AT*
	NL No Lamp	18R 18" (450 mm)	
		24R* 24" (600 mm)	

ORDERING EXAMPLE: ▶ **PF-LED20W-18R-CU** = FIXTURE- LAMP-RISER HEIGHT-FINISH

◊ Includes Super Slot Spike (753900) ◊◊ Includes Long Slot Spike (250015840000)

ACCESSORIES: Specify Separately

Name	Code	Name	Code	Name	Code
SJ-Box	SJ-XX**	ProAim Ratcheting Spike	PARS	Ground Mount	GM-XX**
Post Mount	PM-XX**	Straight Coupling	COUP-XX**	Three-Prong Spike	250020020000
VersaBox	VB-050-XX**	Copper Riser with Fittings	YY-R-GT-XX**		



Powder Coat: Standard



Powder Coat: Specialty

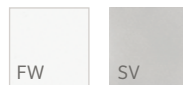

Metal:



[†] Non-returnable

* May require longer lead time ** Finish code ± With 12" (300 mm) riser

Aluminum STANDARD PLUS

DIMENSIONS
Height: 14.5" (368 mm)[‡]
Diameter: 3.6" (91 mm)

SP-A



DIMENSIONS
Height: 15.6" (396 mm)[‡]
Diameter: 6.3" (160 mm)

DL-A



DIMENSIONS
Height: 15.6" (391 mm)[‡]
Diameter: 7.6" (193 mm)

CA-A



DIMENSIONS
Height: 15.5" (394 mm)[‡]
Diameter: 7.1" (180 mm)

DM-A



GENERAL Riser: 3/4" Lamp: G4 Lead: 9' (2.7 m) Material: Aluminum

Fixture	Lamp	Riser Height	Finish
SP-A [‡] DL-A [‡] CA-A [‡] DM-A [‡]	LED20W 123 Lumen Lamp 1.6 W/1.7 VA	12R 12" (300 mm) 18R 18" (450 mm) 24R* 24" (600 mm)	BZ DG WI FB SB FW ^{†‡§} SV ^{†‡§}

ORDERING EXAMPLE: ▶ SP-A-LED20W-12R-BZ = FIXTURE-LAMP-RISER-FINISH

[‡] Includes Super Slot Spike (753900) ^{‡‡} Includes Long Slot Spike (250015840000)

ACCESSORIES: Specify Separately

Name	Code	Name	Code	Name	Code
SJ-Box	SJ-XX**	ProAim Ratcheting Spike	PARS	Ground Mount	GM-XX**
Post Mount	PM-XX**	Straight Coupling	COUP-XX**	Three-Prong Spike	250020020000
VersaBox	VB-050-XX**	Copper Riser with Fittings	YY-R-GT-XX**	Aluminum Straight Coupling	COUP-XX**
Straight Riser	YY-R-XX**				



Powder Coat: Standard



Powder Coat: Specialty

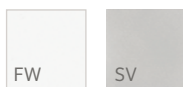

[†] Non-returnable [§] DL-A, CA-A, DM-A only
^{*} May require longer lead time ^{**} Finish code ± With 12" (300 mm) riser

STANDARD PLUS



DIMENSIONS
Height: 15.6" (396 mm)*
Diameter: 6.0" (152 mm)

PL



DIMENSIONS
Height: 15.0" (381 mm)*
Diameter: 5.0" (127 mm)

TM

GENERAL Riser: 3/4" Lamp: G4 Lead: 9' (2.7 m) Material: Aluminum

Fixture	Lamp	Riser Height	Finish
PL [◊] TM [◊]	LED20W 123 Lumen Lamp 1.6 W/1.7 VA	12R 12" (300 mm)	BZ DG WI FB SB FW* ⁺ SV**
	NL No Lamp	18R 18" (450 mm)	
		24R 24" (600 mm)	

ORDERING EXAMPLE: ▶ PL-LED20W-12R-BZ = FIXTURE-LAMP-RISER-FINISH

[◊]Includes Long Slot Spike (250015840000)

ACCESSORIES: Specify Separately

Name	Code	Name	Code	Name	Code
SJ-Box	SJ-XX**	Straight Coupling	COUP-XX**	ProAim Ratcheting Spike	PARS
Post Mount	PM-XX**	Aluminum Riser	YY-R-XX**	Ground Mount	GM-XX**
VersaBox	VB-050-XX**	Three-Prong Spike	250020020000		



Powder Coat: Standard



Powder Coat: Specialty

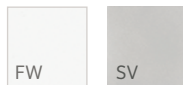

+ Non-returnable * May require longer lead time ** Finish code

STANDARD PLUS

DIMENSIONS

Height: 21.0" (523 mm)
 Diameter: 4.3" (109 mm)
 Lamp: G4
 Lead: 9' (2.7 m)
 Material: Brass



C-PL-4

DIMENSIONS

Height: 21.5" (546 mm)
 Diameter: 6.5" (165 mm)
 Lamp: G4
 Lead: 9' (2.7 m)
 Material: Brass



C-PL-7

Fixture	Lamp	Riser Height	Finish
C-PL-4 [†]	LED20W 123 Lumen Lamp 1.6 W/1.7 VA	18R 18" (450 mm)	AB

C-PL-7[†]

ORDERING EXAMPLE: ▶ C-PL-7-LED20W-18R-AB = FIXTURE-LAMP-RISER-FINISH

[†] Includes Long Slot Spike (250015840000)

ACCESSORIES: Specify Separately

Name	Code	Name	Code	Name	Code
SJ-Box	SJ-XX**	VersaBox	VB-050-XX**	ProAim Ratcheting Spike	PARS
Post Mount	PM-XX**	Three-Prong Spike	250020020000	Ground Mount	GM-XX**



C-PL-4-LED20W-18R-AB
 C-PL-7-LED20W-18R-AB

DP STANDARD PREMIUM



Fixture	Lamp	Riser Height	Finish
DP [†]	LED20W 123 Lumen Lamp 1.6 W/1.7 VA	12R 12" (300 mm)	BZ DG WI FB SB FW** SV** CU NP**
	NL No Lamp	18R 18" (450 mm)	
		24R 24" (600 mm)	

ORDERING EXAMPLE: ▶ DP-LED20W-18R-CU = FIXTURE-LAMP-RISER-FINISH

[†] Includes Super Slot Spike (753900)

Dimensions

Height: 13.5" (343 mm)[†]
 Diameter: 2.9" (74 mm)
 Riser Diameter: 1/2"
 Lamp: G4
 Lead: 9' (2.7 m)
 Material: Copper/Brass

ACCESSORIES: Specify Separately

Name	Code	Name	Code	Name	Code
SJ-Box	SJ-XX**	Copper Riser with Fittings	YY-R-GT-XX**	Aluminum Straight Coupling	COUP-XX**
Post Mount	PM-XX**	Three-Prong Spike	250020020000	ProAim Ratcheting Spike	PARS
VersaBox	VB-050-XX**	Ground Mount	GM-XX**		



Powder Coat: Standard



Powder Coat: Specialty

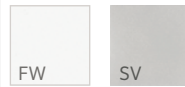

Metal



[†] Non-returnable

* May require longer lead time ** Finish code * Total delivered lumens ± With 12" (300 mm) riser

GN STANDARD PREMIUM



Fixture	Lamp	Riser Option	Finish
GN ^o	LED20W 123 Lumen Lamp 1.6 W/1.7 VA	18R 18" (450 mm)	CU
	NL No Lamp	24R 24" (600 mm)	
		36R 36" (900 mm)	

ORDERING EXAMPLE: ▶ **GN-LED20W-24R-CU** = FIXTURE-LAMP-RISER-FINISH

^oIncludes Long Slot Spike (250015840000)

Dimensions

Height: 22.1" (563 mm)
 with 18" (450 mm) riser
 Diameter: 10.0" (254 mm)
 Riser Diameter: 1 1/4"
 Lamp: G4
 Lead: 9' (2.7 m)
 Material: Brass

ACCESSORIES: Specify Separately

Name	Code	Name	Code	Name	Code
SJ-Box	SJ-XX**	Copper Riser with Fittings	YY-R-GT-XX**	VersaBox	VB-050-XX**
Post Mount	PM-XX**	Three-Prong Spike	250020020000	ProAim Ratcheting Spike	PARS
Ground Mount	GM-XX**				



Metal



** Finish code

TD STANDARD PREMIUM



Fixture	Lamp	Riser Option	Finish
TD ^o	12 12 W Incandescent	[blank] Standard 18" (450 mm)	BZ DG WI FB SB FW** SV** CU NP**
	18 18 W Incandescent	XT Extra Tall 30" (750 mm)	
	25 25 W Incandescent		

ORDERING EXAMPLE: ▶ TD-12-CU = FIXTURE-LAMP-FINISH

^oIncludes Long Slot Spike (250015840000)

ACCESSORIES: Specify Separately

Dimensions

Height: 18.0" (457 mm)
 XT: 29.5" (749 mm)
 Diameter: 5.0" (127 mm)
 Riser Diameter: 3/8"
 Lamp: SCB
 Lead: 9' (2.7 m)
 Material: Copper/Brass

Name	Code	Name	Code	Name	Code
SJ-Box	SJ-XX**	Copper Riser with Fittings	YY-R-GT-XX**	VersaBox	VB-050-XX**
Post Mount	PM-XX**	Three-Prong Spike	250020020000	ProAim Ratcheting Spike	PARS



FG STANDARD PREMIUM



Fixture	Lamp	Finish
FG ^o	12 12 W Incandescent	BZ DG WI FB SB FW** SV** CU NP**
	18 18 W Incandescent	
	25 25 W Incandescent	

ORDERING EXAMPLE: ▶ FG-25-CU = FIXTURE-LAMP-FINISH

^oIncludes Long Slot Spike (250015840000)

ACCESSORIES: Specify Separately

Dimensions

Height: 18.0" (457 mm)
 Diameter: 5.0" (127 mm)
 Riser Diameter: 3/8"
 Lamp: G4
 Lead: 9' (2.7 m)
 Material: Copper/Brass

Name	Code	Name	Code	Name	Code
SJ-Box	SJ-XX**	Copper Riser with Fittings	YY-R-GT-XX**	VersaBox	VB-050-XX**
Post Mount	PM-XX**	Three-Prong Spike	250020020000	ProAim Ratcheting Spike	PARS



Powder Coat: Standard



Powder Coat: Specialty

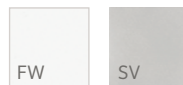

Metal



+ Non-returnable * May require longer lead time ** Finish code

AL STANDARD PLUS



Fixture	Lamp	Finish
AL ^o	12	12 W Incandescent
	18	18 W Incandescent
	25	25 W Incandescent

ORDERING EXAMPLE: ▶ **AL-18-BZ** = FIXTURE-LAMP-FINISH

^oIncludes Long Slot Spike (250015840000)

Dimensions

Height: 27.5" (699 mm)
 Diameter: 5.6" (142 mm)
 Riser Diameter: ¼"
 Lamp: SCB
 Lead: 9' (2.7 m)
 Material: Aluminum

ACCESSORIES: Specify Separately

Name	Code	Name	Code	Name	Code
SJ-Box	SJ-XX**	Copper Riser with Fittings	YY-R-GT-XX**	VersaBox	VB-050-XX**
Post Mount	PM-XX**	Three-Prong Spike	250020020000	ProAim Ratcheting Spike	PARS



PM STANDARD PLUS



Fixture	Lamp	Finish
PM ^o	LED20WWF	261 Lumen Lamp 4.0 W/4.3 VA
	LED35WWF	337 Lumen Lamp 5.0 W/5.4 VA
	ZD35WWF	337 Lumen Lamp 5.0 W/5.4 VA
	NL	No Lamp

ORDERING EXAMPLE: ▶ **PM-LED20WWF-BZ** = FIXTURE-LAMP-FINISH

^oIncludes Long Slot Spike (250015840000)

Dimensions

Height: 14.0" (356 mm)
 Diameter: 2.5" (64 mm)
 Lamp: MR-16
 Lead: 9' (2.7 m)
 Material: Aluminum

ACCESSORIES: Specify Separately

Name	Code
Post Mount	PM-XX**



Powder Coat: Standard



Powder Coat: Specialty

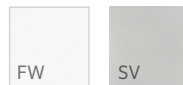

+ Non-returnable * May require longer lead time ** Finish code

DS STANDARD



Fixture	Lamp	Riser Height	Finish
DS [◊]	NL No Lamp	12R 12" (300 mm)	BZ DG WI FB SB FW [†] SV [†]
		18R 18" (450 mm)	
		24R 24" (600 mm)	

ORDERING EXAMPLE: ▶ **DS-NL-24R-SB** = FIXTURE-LAMP-RISER-FINISH

[◊] Includes Long Slot Spike (250015840000)

Dimensions

Height: 13.8" (351 mm)[±]
 Diameter: 6.0" (152 mm)
 Riser Diameter: ½"
 Lamp: G4
 Lead: 9' (2.7 m)
 Material: Aluminum

ACCESSORIES: Specify Separately

Name	Code	Name	Code	Name	Code
SJ-Box	SJ-XX**	Straight Coupling	COUP-XX**	ProAim Ratcheting Spike	PARS
Post Mount	PM-XX**	Three-Prong Spike	250020020000		
VersaBox	VB-050-XX**	Ground Mount	GM-XX**		



DR STANDARD



Fixture	Lamp	Riser Height	Finish
DR [◊]	NL No Lamp	12R 12" (300 mm)	BZ DG WI FB SB FW [†] SV [†]
		18R 18" (450 mm)	
		24R 24" (600 mm)	

ORDERING EXAMPLE: ▶ **DR-NL-18R-SB** = FIXTURE-LAMP-RISER-FINISH

[◊] Includes Long Slot Spike (250015840000)

Dimensions

Height: 14.3" (363 mm)[±]
 Diameter: 10.0" (254 mm)
 Riser Diameter: ½"
 Lamp: G4
 Lead: 9' (2.7 m)
 Material: Aluminum

ACCESSORIES: Specify Separately

Name	Code	Name	Code	Name	Code
SJ-Box	SJ-XX**	Straight Coupling	COUP-XX**	ProAim Ratcheting Spike	PARS
Post Mount	PM-XX**	Three-Prong Spike	250020020000		
VersaBox	VB-050-XX**	Ground Mount	GM-XX**		



Powder Coat: Standard



Powder Coat: Specialty

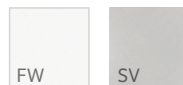

[±] Non-returnable * May require longer lead time ** Finish code * Total delivered lumens * With 12" (300 mm) riser

Use path lights to accent landscape features such as shrubs, flowers, and planters.



STANDARD SERIES

Wall Lights

Add wall lights to your lighting design to increase safety, define perimeters, and softly enhance architectural elements and stonework.

Choose from a variety of elegant styles to seamlessly integrate wall lighting into any setting.



LINEAR AND CIRCULAR WALL LIGHTS



MM-LED20W-BZ

Signifies products available for quick delivery



Identifies UL rated products



Signifies CE or RCM certified products



IP rating indicates water and dust resistance



Indicates minimum quantity



CG STANDARD PREMIUM



Fixture	Lamp	Finish
CG ^o	NL No Lamp	BS

ORDERING EXAMPLE: ▶ **CG-NL-BS** = FIXTURE-LAMP-FINISH

Dimensions

Exposed Depth: 3.1" (80 mm)
 Diameter: 3.0" (76 mm)
 Conduit: 2.0" (51 mm) Diameter
 Lamp: MR-8
 Lead: 10' (3 m)
 Material: Brass

^oIncludes 2" Schedule 40 Conduit (250013670000)



CP STANDARD PREMIUM



Fixture	Lamp	Finish
CP ^o	LED20W 123 Lumen Lamp 1.6 W/1.7 VA each	BZ DG WI FB SB FW* [†] SV* [†] CU NP* [†]

ORDERING EXAMPLE: ▶ **CP-LED20W-BZ** = FIXTURE-LAMP-FINISH

Dimensions

Height: 3.5" (89 mm)
 Width: 5.0" (127 mm)
 Depth: 4.3" (110 mm)
 Exposed Depth: 0.5" (13 mm)
 Lamp: G4
 Lead: 10' (3 m)
 Material: Copper

^oIncludes Sleeve and Cover (250022040000)

ACCESSORIES: Specify Separately

Name	Code
Wall Light Connection Kit	EKITWALL



LM STANDARD PREMIUM



Fixture	Lamp	Finish
LM ^o	LED40W 2 x 123 Lumen Lamps 2 x 1.6 W/1.7 VA	BZ DG WI FB SB FW* [†] SV* [†] CU NP* [†]

ORDERING EXAMPLE: ▶ **LM-LED40W-CU** = FIXTURE-LAMP-FINISH

Dimensions

Height: 3.5" (89 mm)
 Width: 9.0" (229 mm)
 Depth: 4.3" (110 mm)
 Exposed Depth: 0.5" (13 mm)
 Lamp: G4
 Lead: 10' (3 m)
 Material: Copper

^oIncludes Sleeve and Cover (250022030000)

ACCESSORIES: Specify Separately

Name	Code
Wall Light Connection Kit	EKITWALL



Powder Coat: Standard



Powder Coat: Specialty

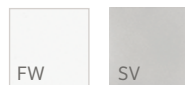

Metal



[†] Non-returnable
^{*} May require longer lead time ^{**} Finish code

MM STANDARD PLUS



Fixture	Lamp	Finish
MM	LED20W 123 Lumen Lamp 1.6W/1.7VA	BZ DG WI FB SB BS NP**

ORDERING EXAMPLE: ▶ MM-LED20W-BZ = FIXTURE-LAMP-FINISH

Dimensions

Depth: 1.8" (45 mm)
Diameter: 3.3" (83 mm)
Lamp: G4
Lead: 10' (3 m)
Material: Brass or Aluminum



MM-LED20W-BZ

UN STANDARD PREMIUM



Fixture	Lamp	Finish
UN ^o	LED20W 123 Lumen Lamp 1.6 W/1.7 VA	BZ DG WI FB SB FW** SV** BS NP** CB DT

ORDERING EXAMPLE: ▶ UN-LED20W-CB = FIXTURE-LAMP-FINISH

^o Includes Sleeve and Cover (250022040000)

ACCESSORIES: Specify Separately

Dimensions

Height: 3.6" (91 mm)
Width: 5.2" (132 mm)
Depth: 4.4" (112 mm)
Exposed Depth: 1.1" (28 mm)
Lamp: G4
Lead: 10' (3 m)
Material: Brass or Composite

Name	Code
Wall Light Connection Kit	EKITWALL



PD STANDARD PREMIUM



Fixture	Lamp	Finish
PD ^o	LED40W 2 x 123 Lumen Lamp 2 x 1.6 W/1.7 VA	BZ DG WI FB SB FW** SV** BS NP** CB DT

ORDERING EXAMPLE: ▶ PD-LED40W-CB = FIXTURE-LAMP-FINISH

^o Includes Sleeve and Cover (250022030000)

ACCESSORIES: Specify Separately

Dimensions

Height: 3.5" (89 mm)
Width: 9.0" (229 mm)
Depth: 4.4" (112 mm)
Exposed Depth: 1.1" (28 mm)
Lamp: G4
Lead: 10' (3 m)
Material: Brass or Composite

Name	Code
Wall Light Connection Kit	EKITWALL



Powder Coat: Standard



Powder Coat: Specialty

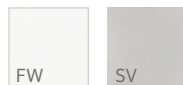

Metal

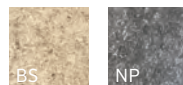

Composite

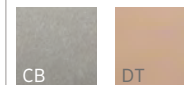

+ Non-returnable

* May require longer lead time ** Finish code

LD STANDARD



Fixture	Lamp	Finish
LD	LED20W 74 Lumens* 1.6 W/1.7 VA	BZ DG WI FB SB

ORDERING EXAMPLE: ▶ LD-LED20W-BZ = FIXTURE-LAMP-FINISH

Dimensions

Height: 1.0" (25 mm)
 Width: 5.9" (150 mm)
 Exposed Depth: 0.8" (20 mm)
 Lamp: G4
 Lead: 10' (3 m)
 Material: Aluminum



LD-LED20W-BZ
LD-LED20W-FB



LD-LED20W-BZ
LD-LED20W-FB

C-LL STANDARD PLUS



Fixture	Lamp	Finish
C-LL	LED20W 151 Lumens* 4.0 W/4.2 VA	AB

ORDERING EXAMPLE: ▶ C-LL-LED20W-AB = FIXTURE-LAMP-FINISH

Dimensions

Height: 0.8" (19 mm)
 Width: 6.9" (175 mm)
 Exposed Depth: 0.8" (20 mm)
 Lamp: Integrated
 Lead: 10' (3 m)
 Material: Brass



C-LL-LED20W-AB

Powder Coat: Standard



Metal



* Total delivered lumens



Use wall lights to accent stone architecture or brickwork.



Down lights provide clean transitions and effective top-down illumination to highlight architecture, patios, verandas, gathering spaces, and more.

FX Luminaire down lights are specially engineered to guide water away from the fixtures. Choose from a range of accessories to optimize installation in any setting.



STANDARD SERIES

Down Lights

MOUNTED AND HANGING LIGHTS

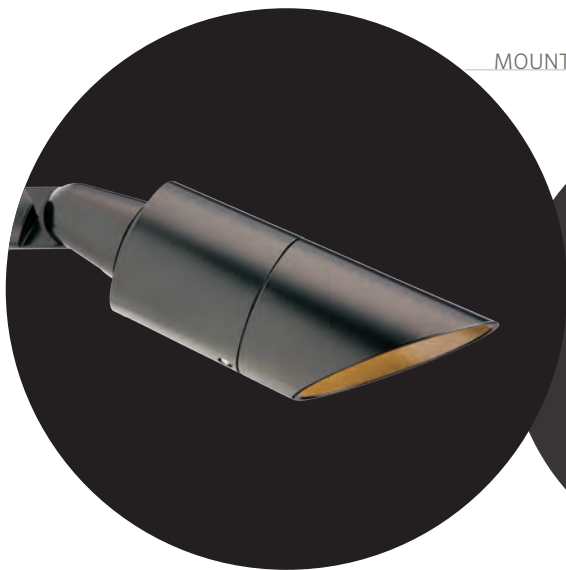

MD-LED20WFL-BZ

Signifies products available for quick delivery



Identifies UL rated products



Signifies CE or RCM certified products



GM-XX

Indicates requirements for CE certification



IP rating indicates water and dust resistance

MD STANDARD PLUS

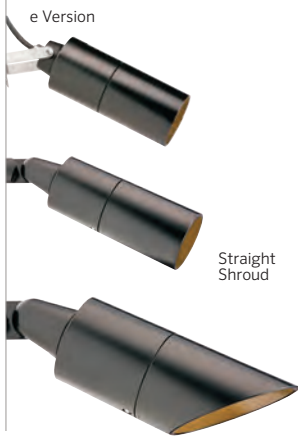

Fixture	Lamp	Compliance	Shroud Option	Finish
MD	LED20WFL 261 Lumen Lamp 4.0 W/4.3 VA	[blank] Mini Mount included (UL)	[blank] 45° Angled Shroud	BZ DG WI FB SB FW†† SV††
	LED35WFL 337 Lumen Lamp 5.0 W/5.4 VA	e Bracket Mount (CE)	SS 3" (76 mm) Straight Shroud	
	LED50WFL 447 Lumen Lamp 6.0 W/6.5 VA			
	ZD35WFL 337 Lumen Lamp 5.0 W/5.4 VA Zone/ Dim with Luxor®			
	NL No Lamp			

ORDERING EXAMPLE: ▶ **MD-LED35WFL-SB** = FIXTURE-LAMP-FINISH

Dimensions

Length: 10.5" (267 mm)
Diameter: 3.0" (76 mm)
Lamp: MR-16
Lead: 10' (3 m)
Material: Aluminum

ACCESSORIES: Specify Separately

Name	Code	Name	Code	Name	Code
TreeBox	TB-XX**	Straight Coupling	COUP-XX**	Hex Baffle (MR-16)	250015260000
Mini J-Box	MJB-050-XX**	90° Elbow Fitting	ELBW-050-XX**	Solite Spread (MR-16)	250015240000
Wall Plate, 1-G	WP-1G-050-XX**	T-Mount Fitting	TMNT-050-XX**	Frosted Lens (MR-16)	250015170000
Wall Plate, Rnd	WP-RD-050-XX**	Straight Riser	YY-R-XX**	RecessorRing (MR-16)	RRMR16
Mini Mount	MM-050-XX				



C-DL STANDARD PLUS



Fixture	Lamp	Finish
C-DL°	LED20WFL 91 Lumens* 4.0 W/4.3 VA	AB
	LED35WFL 138 Lumens* 5.0 W/5.4 VA	
	NL No Lamp	

ORDERING EXAMPLE: ▶ **C-DL-LED20WFL-AB** = FIXTURE-LAMP-FINISH

° Includes Wall Canopy

Dimensions

Length: 10.7" (272 mm)
Diameter: 2.9" (74 mm)
Lamp: MR-16
Lead: 26' (8 m)
Material: Brass

ACCESSORIES: Specify Separately

Name	Code	Name	Code	Name	Code
Hex Baffle (MR-16)	250015260000	Solite Spread (MR-16)	250015240000	Frosted Lens (MR-16)	250015170000



Powder Coat: Standard



Powder Coat: Specialty

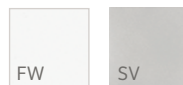

Metal



† Non-returnable

* May require longer lead time ** Finish code * Total delivered lumens

TC STANDARD PREMIUM



Fixture	Lamp	Finish
TC	LED203NF 135 Lumens* 2.3 W/3.8 VA 3,000K	BZ DG WI FB SB FW** SV** CU NP**
	NL No Lamp	

ORDERING EXAMPLE: ▶ TC-LED203NF-CU = FIXTURE-LAMP-FINISH



Dimensions

Height: 3.5" (89 mm)
 Width/Depth: 2.8" (70 mm)
 Lamp: AR-11
 Material: Copper/Brass

CL STANDARD PREMIUM



Fixture	Lamp	Finish
CL	LED203NF 135 Lumens* 2.3 W/3.8 VA 3,000K	BZ DG WI FB SB FW** SV** CU NP**
	NL No Lamp	

ORDERING EXAMPLE: ▶ CL-LED203NF-CU = FIXTURE-LAMP-FINISH



Dimensions

Height: 3.5" (89 mm)
 Diameter: 3.3" (83 mm)
 Lamp: AR-11
 Material: Copper/Brass

Powder Coat: Standard



Powder Coat: Specialty

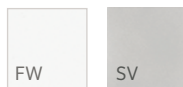

Metal



† Non-returnable

* May require longer lead time ** Finish code * Total delivered lumens

TS STANDARD PLUS



Fixture	Lamp	Finish
TS	NL No Lamp	BZ DG WI FB SB FW** SV** CU NP**
LED203NF 135 Lumens* 2.3 W/3.8 VA		

ORDERING EXAMPLE: ▶ TS-LED203NF-FW = FIXTURE-LAMP-FINISH

Dimensions

Length: 6.5" (165 mm)
 Diameter: 2.4" (61 mm)
 Lamp: AR-11
 Material: Copper or Aluminum

ACCESSORIES: Specify Separately

Name	Code	Name	Code	Name	Code
Mini J-Box	MJ-TS-XX**	VersaBox	VB-TS-XX**	TS Lamp Tool	250010130000



LS STANDARD PREMIUM



Fixture	Lamp	Finish
LS	12 12 W Incandescent	CU NP**

ORDERING EXAMPLE: ▶ LS-12-CU = FIXTURE-LAMP-FINISH

Dimensions

Height: 3.0" (76 mm)
 Diameter: 1.6" (41 mm)
 Lamp: SCB
 Material: Copper/Brass



VL STANDARD PREMIUM



Fixture	Lamp	Finish
VL	LED203NF 135 Lumens* 2.3 W/3.8 VA	BZ DG WI SB FB FW** SV** CU NP**
	NL No Lamp	

ORDERING EXAMPLE: ▶ VL-LED203NF-CU = FIXTURE-LAMP-FINISH

Dimensions

Height: 4.7" (119 mm)
 Diameter: 2.0" (51 mm)
 Lamp: AR-11
 Material: Copper/Brass



Powder Coat: Standard



Powder Coat: Specialty

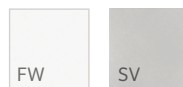

Metal



† Non-returnable

* May require longer lead time ** Finish code * Total delivered lumens

*From gardens to outdoor dining areas,
we offer a full suite of down lights to meet
the needs of any installation.*





WELL LIGHTS AND UNDERWATER LIGHTS

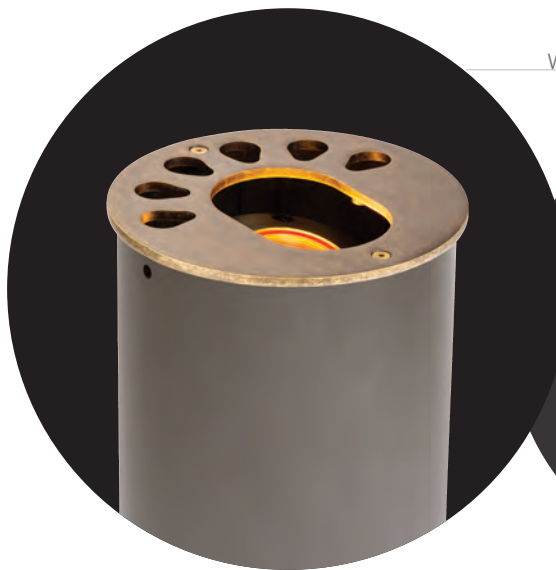

Signifies products available for quick delivery



Identifies UL rated products



Signifies CE or RCM certified products



Indicates requirements for CE certification



IP rating indicates water and dust resistance



STANDARD SERIES

Specialty Lights

Our specialty lights are carefully engineered for peak performance in lighting designs that stretch the boundaries of creativity.

From underwater to in-grade applications, FX Luminaire specialty lights are designed to bring statement pieces to life.

FC STANDARD PREMIUM



Ring

Louver



Cowling

Fixture	Lamp	Compliance	Style Option	Finish
FC ^o	NL	No Lamp	RG Ring	BS NP** CB DT
	LED20W (FL or WF)	261 Lumen Lamp 4.0 W/4.3 VA	LV Louver	
	LED35W (FL or WF)	337 Lumen Lamp 5.0 W/5.4 VA	CW Cowling	
	LED50WFL	447 Lumen Lamp 6.0 W/6.5 VA		
	ZD35W (FL or WF)	337 Lumen Lamp 5.0 W/5.4 VA Zone/Dim with Luxor		

ORDERING EXAMPLE: ▶ **FC-LED20WFL-CW-CB** = FIXTURE-LAMP-STYLE OPTION-FINISH

^oIncludes Construction Sleeve (250014350000)



Dimensions

Height: RG: 4.8" (122 mm)

LV: 5.1" (130 mm)

CW: 6.8" (173 mm)

Diameter: 4.0" (102 mm)

Lamp: MR-16

Material: Brass or Composite

RP STANDARD PREMIUM



Ring

Cowling



Louver

Fixture	Lamp	Compliance	Style Option	Finish
RP ^o	LED20WFL	261 Lumen Lamp 4.0 W/4.3 VA	RG Ring	BS NP** CB DT
	LED35WFL	337 Lumen Lamp 5.0 W/5.4 VA	LV Louver	
	LED50WFL	447 Lumen Lamp 6.0 W/6.5 VA	CW Cowling	
	ZD35WFL	337 Lumen Lamp 5.0 W/5.4 VA		
	NL	No Lamp		

ORDERING EXAMPLE: ▶ **RP-LED20WFL-LV-BS** = FIXTURE-LAMP-STYLE OPTION-FINISH

^oIncludes Construction Sleeve (250014350000)



Dimensions

Height: RG: 9.0" (229 mm)

LV: 9.3" (236 mm)

CW: 11.0" (279 mm)

Diameter: 7.0" (178 mm)

Lamp: MR-16

Material: Brass or Composite

Metal



Composite



† Non-returnable

* May require longer lead time ** Finish code * Total delivered lumens



C-IN STANDARD PLUS

Fixture	Lamp	Finish
C-IN	LED35WFL 242 Lumens* 5.0 W/5.4 VA	AB
	LED50WFL 333 Lumens* 6.0 W/6.5 VA	

ORDERING EXAMPLE: ▶ C-IN-LED50WFL-AB = FIXTURE-LAMP-FINISH



C-IN-LED35WFL-AB

Dimensions

Height: 5.5" (140 mm)
 Diameter: 3.8" (97 mm)
 Lamp: MR-16
 Material: Brass



CF STANDARD

Fixture	Lamp	Finish
CF ^o	LED35WFL 690 Lumen Lamp 6.0 W/8.5 VA	CB DT
	LED50WFL 860 Lumen Lamp 10.0 W/11.3 VA	
	NL No Lamp	

ORDERING EXAMPLE: ▶ CF-LED35WFL-CB = FIXTURE-LAMP-FINISH

^oIncludes Construction Sleeve (250014350000)



Dimensions

Height: 9.0" (229 mm)
 Diameter: 6.0" (152 mm)
 Lamp: PAR-36
 Material: Composite



TE STANDARD PREMIUM

Fixture	Lamp	Compliance	Finish
TE ^o	LED20WFL 261 Lumen Lamp 4.0 W/4.3 VA	[blank] (UL)	BZ DG WI
	LED35WFL 337 Lumen Lamp 5.0 W/5.4 VA	e (CE)	SB FB BS
	LED50WFL 447 Lumen Lamp 6.0 W/6.5 VA		NP**
	ZD35WFL 337 Lumen Lamp 5.0 W/5.4 VA		
	NL No Lamp		

ORDERING EXAMPLE: ▶ TE-LED35WFL-BS = FIXTURE-LAMP-FINISH

^oIncludes Construction Sleeve (250014350000)



Dimensions

Height: 9.0" (229 mm)
 Diameter: 6.0" (152 mm)
 Lamp: MR-16
 Material: Brass

Powdercoat: Standard



Metal

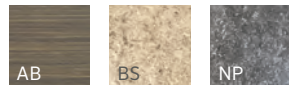

Composite

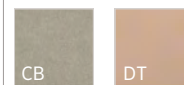

[†] Non-returnable

^{*} May require longer lead time ^{**} Finish code ^{*} Total delivered lumens

LB STANDARD PREMIUM



Fixture	Lamp	Compliance	Finish	Wire Lead
LB	LED20WFL 261 Lumen Lamp 4.0 W/4.3 VA	[blank] (UL)	BS	[blank] 16' (5 m)
	LED35WFL 337 Lumen Lamp 5.0 W/5.4 VA	e (CE)		30 30' (9 m)
	LED50WFL 447 Lumen Lamp 6.0 W/6.5 VA			50 50' (15 m)
	ZD35WFL 337 Lumen Lamp 5.0 W/5.4 VA			
	NL No Lamp			

ORDERING EXAMPLE: ▶ **LB-LED35WFL-BS-30** = FIXTURE-LAMP-FINISH-LEAD



Dimensions

Height: 5.2" (132 mm)
 Diameter: 3.0" (76 mm)
 Lamp: MR-16
 Material: Brass

SRP STANDARD



Fixture	Length	Color Temp
SRP	10 10' (3.1 m)	W Warm (2,700K)
	40 40' (12.2 m)	S Soft (3,000K)

ORDERING EXAMPLE: ▶ **SRP-40-S** = FIXTURE-LENGTH-COLOR TEMP



Dimensions

Length: 10' (3 m)
 or 40' (12.2 m)
 Height: 0.6" (15 mm)
 Depth: 0.6" (15 mm)
 Lead: 10' (3 m)
 Material: Silicone

MOUNTING & ACCESSORIES Options

Catalog No.	Description
SRP-MNT	Hardscape Mount
SRP-CHN	Aluminum Channel Mount
SRP-CONNECT*	Splice Connectors
SRP-CUT	Cutter Tool

* Includes jumper cables, closed-end connectors, and power feeds.

Metal



Use specialty lights to bring architecture and outdoor environments to life.

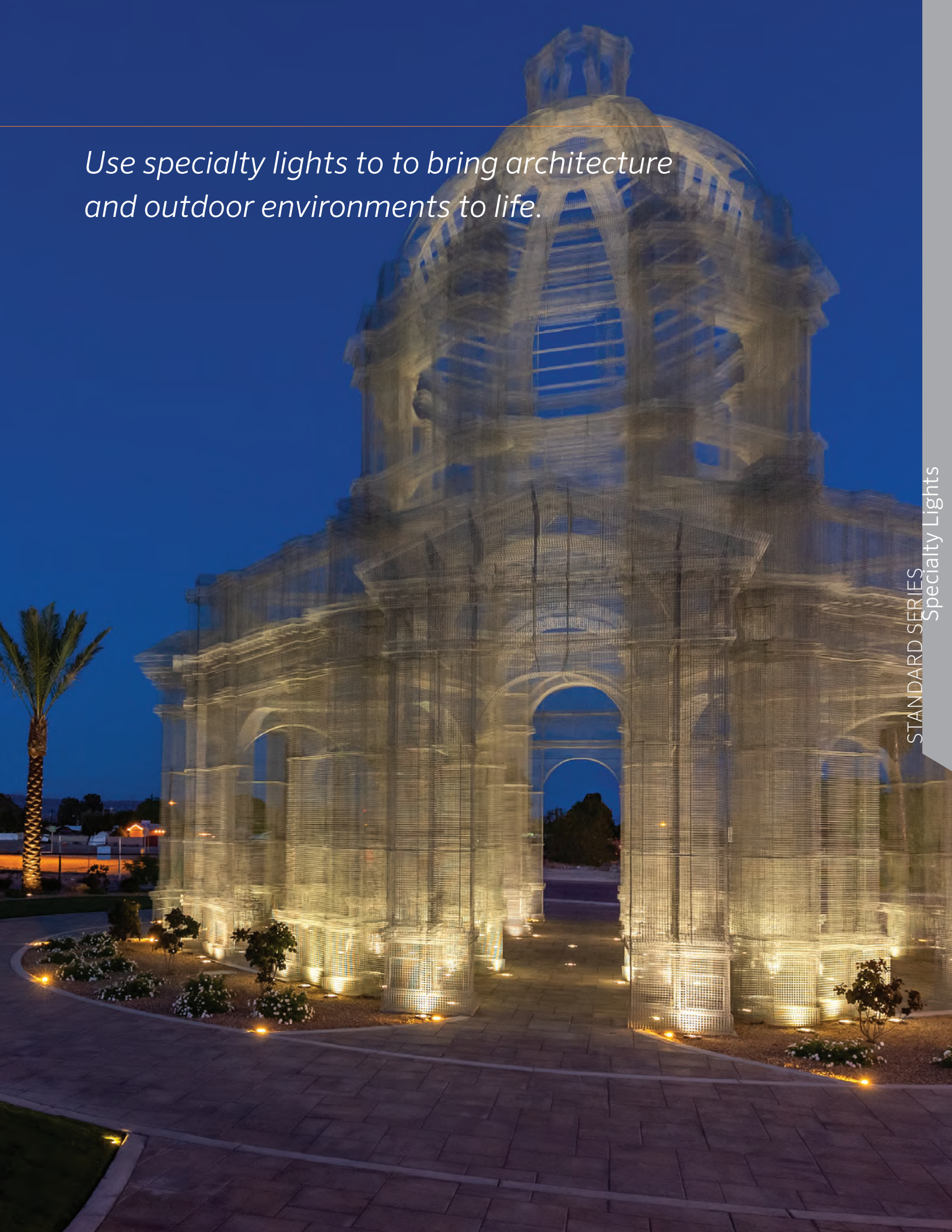

VALUE LINE



Beauty and timeless design are essential components of any lighting installation, regardless of budget. With the FX Luminaire Value Line, you can offer customers a high-quality, system-level lighting solution at a lower price.

Designed with rounded, minimalist features and durable die-cast aluminum, Value Line fixtures are highly versatile and affordable.



PATH AND DIRECTIONAL LIGHTS



WS-LED35W-BZ

Signifies products available for quick delivery



Identifies UL rated products



Signifies CE or RCM certified products



IP rating indicates water and dust resistance



Indicates minimum quantity

RS STANDARD



Long Shroud

Fixture	Lamp	Shroud Option	Finish
RS ^o	LED20WFL 261 Lumen Lamp 4.0 W/4.3 VA	[blank] 15° Angled Shroud	BZ DG WI SB FB
	LED35WFL 337 Lumen Lamp 5.0 W/5.4 VA	LS 45° Angled Long Shroud	
	LED50WFL 447 Lumen Lamp 6.0 W/6.5 VA		
	ZD35WFL 337 Lumen Lamp 5.0 W/5.4 VA Zone/Dim with Luxor [®]		
	NL No Lamp		

ORDERING EXAMPLE: ▶ **RS-LED20WFL-LS-BZ** = FIXTURE-LAMP-SHOULD OPTION-FINISH

^oIncludes Super Slot Spike (753900)

Dimensions

Height: 6.6" (168 mm)
Long Shroud: 7.8" (198 mm)
Diameter: 2.5" (64 mm)
Lamp: MR-16
Lead: 10' (3 m)
Material: Zinc

ACCESSORIES: Specify Separately

Name	Code	Name	Code	Name	Code
Ground Mount	GM-XX**	Straight Coupling	COUP-XX**	Hex Baffle (MR-16)	250015260000
SJ-Box	SJ-XX**	90° Elbow Fitting	ELBW-050-XX**	Frosted Lens (MR-16)	250015170000
Straight Riser	YY-R-XX**	T-Mount Fitting	TMNT-050-XX**	Solite Spread (MR-16)	250015240000



RS-LED20WFL-BZ RS-NL-BZ



RS-LED20WFL-BZ RS-NL-BZ

WS STANDARD



Fixture	Lamp	Finish
WS ^o	LED35W 170 Lumen Lamp 2.4 W/2.6 VA	BZ DG WI FB SB

ORDERING EXAMPLE: ▶ **WS-LED35W-SV** = FIXTURE-LAMP-FINISH

^oIncludes Super Slot Spike (753900)

Dimensions

Height: 6.4" (163 mm)
Width: 4.0" (102 mm)
Lamp: G4
Lead: 10' (3 m)
Material: Aluminum

ACCESSORIES: Specify Separately

Name	Code	Name	Code	Name	Code
Mini J-Box	MJB-050-XX**	Straight Coupling	COUP-XX**	Post Mount	PM-XX**
VersaBox	VB-050-XX**	90° Elbow Fitting	ELBW-050-XX**	Straight Riser	YY-R-XX**
SJ-Box	SJ-XX**	T-Mount Fitting	TMNT-050-XX**	Mini Mount	MM-050-XX



WS-LED35W-BZ



WS-LED35W-BZ

Powder Coat: Standard



** Finish code

SP-A STANDARD



Fixture	Lamp	Riser Option	Finish
SP-A ^o	LED20W 123 Lumen Lamp 1.6 W/1.7 VA	12R 12" (300 mm)	BZ DG WI FB SB
		18R 18" (450 mm)	
		24R* 24" (600 mm)	

ORDERING EXAMPLE: ▶ SP-A-LED20W-12R-BZ = FIXTURE-LAMP-RISER-FINISH

^oIncludes Super Slot Spike (753900)

Dimensions

Height: 14.5" (368 mm)*
 Diameter: 3.6" (91 mm)
 Riser Diameter: 3/4"
 Lamp: G4
 Lead: 9' (2.7 m)
 Material: Aluminum

ACCESSORIES: Specify Separately

Name	Code	Name	Code	Name	Code
SJ-Box	SJ-XX**	ProAim Ratcheting Spike	PARS	Ground Mount	GM-XX**
Post Mount	PM-XX**	Copper Riser with Fittings	YY-R-GT-XX**	Three-Prong Spike	250020020000
VersaBox	VB-050-XX**	Aluminum Straight Coupling	COUP-XX**	Straight Coupling	COUP-XX**
Straight Riser	YY-R-XX**				



LD STANDARD



Fixture	Lamp	Finish
LD	LED20W 74 Lumens * 1.6 W/1.7 VA	BZ DG WI FB SB

ORDERING EXAMPLE: ▶ LD-LED20W-BZ = FIXTURE-LAMP-FINISH

Dimensions

Height: 1.0" (25 mm)
 Width: 5.9" (150 mm)
 Exposed Depth: 0.8" (20 mm)
 Lamp: G4
 Lead: 10' (3.1 m)
 Material: Aluminum



Powder Coat: Standard



** Finish code * With 12" (300 mm) riser



C-Line

Our contemporary, elegant C-Line fixtures are especially at home in coastal environments. That's because they are made with durable, midgrade brass that effectively resists corrosion caused by salty air and dissolved minerals.

The special brass used in C-Line fixtures costs less than traditional brass. This means you can offer FX Luminaire's premium appeal to a wider range of customers.



PATH AND DIRECTIONAL LIGHTS



CUL-LED20WFL-AS-AB

Signifies products available for quick delivery



Identifies UL rated products



C-UL STANDARD PLUS



Adjustable Shroud

Fixture	Lamp	Shroud	Finish
C-UL [◊]	LED20WFL 180 Lumens* 4.0 W/4.3 VA	AS Adjustable Shroud	AB
	LED35WFL 250 Lumens* 5.0 W/5.4 VA		
	NL No Lamp		

ORDERING EXAMPLE: ▶ C-UL-LED20WFL-AS-AB = FIXTURE-LAMP-SHROUD-FINISH

[◊] Includes Long Slot Spike (250015840000)

Dimensions

Height: 6.6" (168 mm)
 Diameter: 2.5" (64 mm)
 Lamp: MR-16
 Lead: 10' (3 m)
 Material: Brass

ACCESSORIES: Specify Separately

Name	Code	Name	Code	Name	Code
Mini J-Box	MJB-050-XX**	Post Mount	PM-XX**	ProAim Ratcheting Spike	PARS
VersaBox	VB-050-XX**	Solite Spread (MR-16)	250015240000	Copper Riser with Fittings	YY-R-GT-XX**
SJ-Box	SJ-XX**	Frosted Lens (MR-16)	250015170000	Gutter Mount	GM-SS



C-UL-LED20WFL-AS-AB

C-WW STANDARD PLUS



Fixture	Lamp	Finish
C-WW [◊]	LED35W 170 Lumen Lamp 2.4 W/2.6 VA	AB

ORDERING EXAMPLE: ▶ C-WW-LED35W-AB = FIXTURE-LAMP-FINISH

[◊] Includes Long Slot Spike (250015840000)

Dimensions

Height: 6.5" (165 mm)
 Width: 4.0" (102 mm)
 Lamp: G4
 Lead: 10' (3 m)
 Material: Brass

ACCESSORIES: Specify Separately

Name	Code	Name	Code	Name	Code
Post Mount	PM-XX**	SJ-Box	SJ-XX**	Copper Riser with Fittings	YY-R-GT-XX**
VersaBox	VB-050-XX**	Gutter Mount	GM-SS	ProAim Ratcheting Spike	PARS



C-WW-LED35W-AB

Metal



** Finish code

C-WWL STANDARD PLUS



Fixture	Lamp		Finish
C-WWL [◊]	LED35WFL	183 Lumens* 5.0 W/5.4 VA	AB
	LED50WFL	218 Lumens* 6.0 W/6.5 VA	

ORDERING EXAMPLE: ▶ C-WWL-LED50WFL-AB = FIXTURE-LAMP-FINISH

[◊] Includes Long Slot Spike (250015840000)

Dimensions

Height: 6.5" (165 mm)
Width: 5.4" (137 mm)
Lamp: MR-16
Lead: 10' (3 m)
Material: Brass

ACCESSORIES: Specify Separately

Name	Code	Name	Code	Name	Code
Post Mount	PM-XX**	SJ-Box	SJ-XX**	Copper Riser with Fittings	YY-R-GT-XX**
VersaBox	VB-050-XX**	Gutter Mount	GM-SS	ProAim Ratcheting Spike	PARS



C-WWL-LED35WFL-AB

C-IN STANDARD PLUS



Fixture	Lamp		Finish
C-IN	LED35WFL	242 Lumens* 5.0 W/5.4 VA	AB
	LED50WFL	333 Lumens* 6.0 W/6.5 VA	

ORDERING EXAMPLE: ▶ C-IN-LED35WFL-AB = FIXTURE-LAMP-FINISH

Dimensions

Length: 5.5" (128 mm)
Diameter: 3.8" (97 mm)
Lamp: MR-16
Lead: 10' (3 m)
Material: Brass



C-IN-LED35WFL-AB

Metal



** Finish code * Total delivered lumens



C-PL-4 STANDARD PLUS

Fixture	Lamp	Riser Height	Finish
C-PL-4 ^o	LED20W 123 Lumen Lamp 1.6 W/1.7 VA	18R 18" (750 mm)	AB

ORDERING EXAMPLE: ▶ C-PL-4-LED20W-18R-AB = FIXTURE-LAMP-RISER-FINISH

^oIncludes Long Slot Spike (250015840000)

Dimensions

Height: 21.0" (523 mm)
 Diameter: 4.3" (109 mm)
 Riser Diameter: 1.0"
 Lamp: G4
 Lead: 9' (2.7 m)
 Material: Brass

ACCESSORIES: Specify Separately

Name	Code	Name	Code	Name	Code
SJ-Box	SJ-XX**	VersaBox	VB-050-XX**	ProAim Ratcheting Spike	PARS
Post Mount	PM-XX**	Three-Prong Spike	250020020000	Ground Mount	GM-XX**



C-PL-4-LED20W-18R-AB



C-PL-7 STANDARD PLUS

Fixture	Lamp	Riser Height	Finish
C-PL-7 ^o	LED20W 123 Lumen Lamp 1.6 W/1.7 VA	18R 18" (750 mm)	AB

ORDERING EXAMPLE: ▶ C-PL-7-LED20W-18R-AB = FIXTURE-LAMP-RISER-FINISH

^oIncludes Long Slot Spike (250015840000)

Dimensions

Height: 21.5" (546 mm)
 Diameter: 6.5" (165 mm)
 Riser Diameter: 1.0"
 Lamp: G4
 Lead: 9' (2.7 m)
 Material: Brass

ACCESSORIES: Specify Separately

Name	Code	Name	Code	Name	Code
SJ-Box	SJ-XX**	VersaBox	VB-050-XX**	ProAim Ratcheting Spike	PARS
Post Mount	PM-XX**	Three-Prong Spike	250020020000	Ground Mount	GM-XX**



C-PL-7-LED20W-18R-AB

Metal



** Finish code * Total delivered lumens

C-DL STANDARD PLUS



Fixture	Lamp	Finish
C-DL [◊]	LED20WFL 91 Lumens* 4.0 W/4.3 VA	AB
	LED35WFL 138 Lumens* 5.0 W/5.4 VA	
	NL No Lamp	

ORDERING EXAMPLE: ▶ C-DL-LED20WFL-AB = FIXTURE-LAMP-FINISH

[◊] Includes wall canopy

Dimensions

Length: 10.7" (272 mm)
 Diameter: 2.9" (73 mm)
 Lamp: MR-16
 Lead: 26' (8 m)
 Material: Brass

ACCESSORIES: Specify Separately

Name	Code	Name	Code	Name	Code
Hex Baffle (MR-16)	250015260000	Solite Spread (MR-16)	250015240000	Frosted Lens (MR-16)	250015170000



C-DL-LED20WFL-BZ

C-LL STANDARD PLUS



Fixture	Lamp	Finish
C-LL	LED20W 151 Lumens* 4.0 W/4.2 VA	AB

ORDERING EXAMPLE: ▶ C-LL-LED20W-AB = FIXTURE-LAMP-FINISH

Dimensions

Height: 0.8" (19 mm)
 Width: 6.9" (175 mm)
 Depth: 0.8" (20 mm)
 Lamp: Integrated LED
 Lead: 10' (3 m)
 Material: Brass



C-LL-LED20W-AB

Metal



* Total delivered lumens



LINE-VOLTAGE SOLUTIONS



Indicates
line-voltage fixture
(110-277 V)



Identifies UL rated
products



Signifies CE or RCM
certified products



IP rating indicates
water and dust
resistance

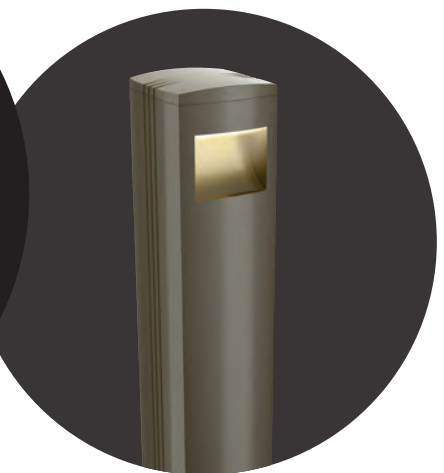



LINE-VOLTAGE Series

With sleek, modern designs and robust engineering, our Line-Voltage Series provides maximum light output and seamless aesthetics for state-of-the-art installations in any environment.

Specify your desired control, output, color temperature, and optics with ultimate flexibility and versatility.

A-CT LINE-VOLTAGE

DIMENSIONS

Length: 8.5" (216 mm)
 LS Length: 10.6" (268 mm)
 Width: 4.0" (102 mm)
 Material: Aluminum



A-CT4

DIMENSIONS

Length: 11.5" (293 mm)
 LS Length: 12.3" (312 mm)
 Width: 5.0" (127 mm)
 Material: Aluminum



A-CT5

Fixture	Power/Control	Output	CCT	Optics	Option	Finish	Mounting ⁺
A-CT4*†	SV 120 V Phase (UL)	L07 499-629 Lumens*	K27 2,700K	SP 20°	[default]	BZ DG WI SB FB FW SV	[default] No kit [◊]
A-CT5*†	UV 110 V-277 V, 0-10 V (CE)	L10 565-867 Lumens*	K30 3,000K	FL 40°	LS Long Shroud (not available with VW & WW)		MKCT4^{◊◊} Required for A-CT4
	HV 220 V-240 V, 0-10 V (CE)	L13 824-1,141 Lumens*	K40 4,000K	WF 60°			
		L20[◊] 1,866 Lumens*		VW[◊] 90°			
				WW[◊] 90°-120°			

ORDERING EXAMPLE: ▶ **A-CT4-SV-L10-K30-FL-FB+MKCT4** = FIXTURE-POWER/CONTROL-OUTPUT-CCT-OPTICS-OPTION-FINISH-MOUNTING

◊ A-CT5 Only ◊◊ A-CT4 Only * Ordered separately



A-BR10 LINE-VOLTAGE

Fixture	Power/Control	Output	CCT
A-BR10*†	SV 120 V Phase (UL)	L07 319-990 Lumens*	K27 2,700K
	UV 110 V/277 V, 0-10 V (UL)	L10 444-1,347 Lumens*	K30 3,000K
	HV 220 V/240 V, 0-10 V (CE)	L13 614-1,803 Lumens*	K40 4,000K
		L20 988-2,977 Lumens*	

Dimensions

Height: 42.0" (1.1 m)
 Width: 9.7" (264 mm)
 Material: Aluminum

Lens	Orientation	Finish	Mounting ⁺
[default] Clear	GP Ground Plane	BZ DG WI SB FB FW SV	MKBR10 Standard kit
FR Frosted	GG Ground/Ground		
	GV Ground/Vertical		

ORDERING EXAMPLE: ▶ **A-BR10-UV-L13-K27-FR-GP-BZ+MKBR10** = FIXTURE-POWER/CONTROL-OUTPUT-CCT-LENS-ORIENTATION-FINISH-MOUNTING

* Ordered separately



Powder Coat: Standard



Powder Coat: Specialty

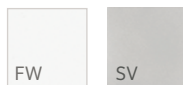

† Non-returnable * May require longer lead time * Total delivered lumens

A-ST5 **LINE-VOLTAGE**



Fixture	Power/Control	Output	CCT	Optics	Finish
A-ST5*	SV 120 V Phase (UL)	L07 569-645 Lumens*	K27 2,700K	SP 20°	BZ DG WI SB FB FW SV
	UV 110 V/277 V, 0-10 V (UL)	L10 824-895 Lumens*	K30 3,000K	FL 40°	
		L13 1,069-1,161 Lumens*	K40 4,000K	WF 60°	
		L20 1,682-1,836 Lumens*			

ORDERING EXAMPLE: ▶ **A-ST5-SV-L10-K30-FL-FW** = FIXTURE-POWER/CONTROL-OUTPUT-CCT-OPTICS-FINISH



Dimensions

Height: 11.5" (293 mm)
Width: 5.0" (127 mm)
Material: Aluminum

A-NK **LINE-VOLTAGE**

DIMENSIONS

Length: 5.8" (147 mm)
Width: 5.8" (147 mm)
Exposed Depth: 0.125" (3.2 mm)
Material: Aluminum



A-NK4

DIMENSIONS

Length: 11.2" (285 mm)
Width: 11.2" (285 mm)
Exposed Depth: 0.125" (3.2 mm)
Material: Aluminum



A-NK6

Fixture	Power/Control	Output	CCT	Lens	Finish	Mounting ⁺
A-NK4**	SV ^{◇◇} 120 V Phase (UL)	L04 205-311 Lumens*	K30 3,000K	[default] ^{◇◇} Clear	BZ DG WI SB FB FW SV	MKNK4 [◇]
A-NK6**	UV 110 V-277 V, 0-10 V (UL)	L10 ^{◇◇} 550-688 Lumens*	K40 4,000K	FR Frosted		MKNK6 ^{◇◇}
	HV ^{◇◇} 220 V-240 V, 0-10 V (CE)	L13 ^{◇◇} 749-930 Lumens*				
		L20 ^{◇◇} 1,162-1,491 Lumens*				

ORDERING EXAMPLE: ▶ **A-NK4-SV-L04-K30-SV+MKNK4** = FIXTURE-POWER/CONTROL-OUTPUT-CCT-LENS-FINISH-MOUNTING

[◇] A-NK4 Only ^{◇◇} A-NK6 Only ⁺ Ordered separately



Powder Coat: Standard



Powder Coat: Specialty

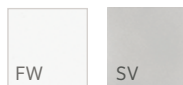

⁺ Non-returnable ^{*} May require longer lead time ^{*} Total delivered lumens

A-HS LINE-VOLTAGE

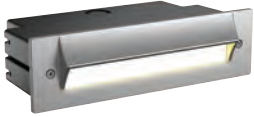

Fixture	Power/Control	Output	CCT
A-HS**	UV 110 V/277 V, 0-10 V (UL)	L06 531 Lumens*	K30 3,000K
		L11 944 Lumens*	K40 4,000K

Dimensions

Height: 2.3" (58 mm)
 Width: 8.0" (203 mm)
 Depth: 3.4" (86 mm)
 Exposed Depth: 0.7" (18 mm)
 Material: Aluminum

Optics	Faceplate	Finish	Mounting*
FG Floor Graze	LS Long Shroud	BZ DG WI SB FB FW SV	MKHS Standard kit

PW Performance Wash

ORDERING EXAMPLE: ▶ A-HS-UV-L06-K30-FG-LS-FB+MKHS = FIXTURE-POWER/CONTROL-OUTPUT-CCT-OPTICS-FACEPLATE-FINISH-MOUNTING

* Ordered separately



A-KN LINE-VOLTAGE



Fixture	Power/Control	Output	CCT	
A-KN**	SV 120 V/160 Hz Phase (UL)	L07 646 Lumens*	K27 2,700K	
		UV 110 V/277 V, 0-10 V (UL)	L10 889 Lumens*	K30 3,000K
		HV 220 V/240 V, 0-10 V (CE)	L13 1,159 Lumens*	K40 4,000K
			L20 1,871 Lumens*	

Dimensions

Height: 15.7" (399 mm)
 Diameter: 10.5" (267 mm)
 Material: Aluminum

Optics	Option	Finish	Mounting*
SP 20°	[default] Ring	BZ DG WI SB FB FW SV	MKKN Standard kit

FL 40°	CW Cowling
--------	------------

WF 60°	SR Slip-Resistant
--------	-------------------

ORDERING EXAMPLE: ▶ A-KN-UV-L20-K40-SP-SR-BZ+MKKN = FIXTURE-POWER/CONTROL-OUTPUT-CCT-OPTICS-OPTION-FINISH-MOUNTING

* Ordered separately



Powder Coat: Standard



Powder Coat: Specialty

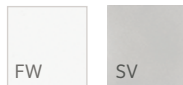

† Non-returnable * May require longer lead time ** Total delivered lumens

A photograph of a garden scene. On the left, a wall made of stacked, irregular stones in shades of grey and brown. A large, leafy green bush with numerous bright red flowers grows against the wall. To the right, a light-colored stucco wall features a dark grey louvered shutter. In the foreground, a gravel bed contains several small green plants with red flowers. A black, cylindrical landscape light fixture is positioned in the lower right corner, casting a soft glow. The overall scene is illuminated by warm, golden light, suggesting late afternoon or early evening.

Push the boundaries of creative and functional lighting design with the FX Luminaire Line-Voltage Series.



When Luxor Technology controls an LED landscape lighting system, lights don't simply turn on and off. They come alive! As FX Luminaire's premium lighting control option, Luxor is the most advanced and flexible low-voltage landscape lighting transformer on the market. The controller combines zoning, dimming, and color control capabilities into a single control system using a simple two-wire path installation.

With Luxor, you can create a range of vibrant lighting designs to offer distinctive looks year-round.

LUXOR[®] SYSTEM

Zoning, Dimming & 30,000 Colors



THE LUXOR APP PROVIDES
MAXIMUM FLEXIBILITY
AND CONVENIENCE —
RIGHT FROM THE PALM
OF YOUR HAND.



LUXOR

Zoning and Dimming + Color

Zoning and Dimming Zoning allows lights to be programmed into preset groups. Dimming allows lights to be set at different intensities from 0-100%.



Color Choose from a spectrum of 30,000 vibrant possibilities.



▲ RED	
HUE	350
SATURATION	96%
INTENSITY	90%





































▲ AMBER	
HUE	42
SATURATION	38%
INTENSITY	75%



▲ BLUE	
HUE	230
SATURATION	81%
INTENSITY	63%

Luxor Compatible Color-Changing Fixtures

					
FB See page 15	NP See page 15	FR NR See page 16	VS CC See page 17	PB See page 19	LC See page 19
					
CA See page 24	DM See page 24	JS See page 24	RW See page 27	PL See page 25	TM See page 25
					
FG See page 26	TD See page 26	LL See page 53	LP See page 53	MO See page 38	SL See page 38
					
LF See page 33	PM See page 72	M-PL See page 29	M-PK See page 28	M-PZ See page 29	M-PJ See page 28
					
NL See page 46	PS See page 46	SD See page 42	DE See page 44	JB See page 43	ZW See page 41
					
VE See page 45	RC See page 42	KT See page 52	KG See page 51	FC See page 51	HP-48 See page 52

LUXOR Controllers



LUXOR AND LSAT CONTROLLERS



WITH LUXOR LINKING,
YOU CAN WIRE LSAT
CONTROLLERS UP TO
3,000' (900 M) AWAY
FROM THE PRIMARY
CONTROLLER.



In addition to incorporating zoning, dimming, and color into a single controller, Luxor can now create up to 40 distinct themes, and comes preset with convenient calendar-based programming, timed sunset and sunrise offsets, dual 15 V outputs, and optional wireless control.

With Luxor Linking, you can hardwire up to nine LSAT, or satellite, controllers while maintaining a single point of control.



LUXOR Features

With complete zoning, dimming, and color generation capabilities — along with optional Wi-Fi control — the Luxor System offers unsurpassed freedom and flexibility for outdoor lighting design.

Primary Features

- Zone control: Turn individual or groups of fixtures on and off at desired times
- Dimming control: Adjust the intensities of individual or groups of fixtures from 0–100%
- Color control: Create 30,000 colors for maximum design potential
- Color palette: Generate and save up to 250 custom colors
- Astronomical timing: Automatically track sunset and sunrise timing by setting your location
- Scene/theme creation: Design up to 40 themes ranging from every-night living to holidays and special celebrations
- Event-based programming: Turn custom themes or lighting fixtures on and off multiple times throughout the night
- Calendar-based programming: Ensure specific programs run only when needed with dedicated date-range programming
- Wireless control: Interact with the controller using iOS® and Android™ devices
- LAN connection: Conveniently incorporate wireless control using the preinstalled LAN module
- Smart home integration: Integrate and control Luxor using today's most popular smart home automation systems

Location Lat: 32.49 Long: -117.77



iOS is a trademark or registered trademark of Cisco in the U.S. and other countries and is used under license. Android is a trademark of Google LLC.



LUXOR



LSAT

Dimensions

Height: 13.0" (330 mm)
 Width: 8.0" (203 mm)
 Depth: 5.0" (127 mm)
 EU Depth: 6.3" (160 mm)

Controller	Wattage	Compliance	Finish
LUX (Primary)	300 300 W	[blank] 120 V	SS M
LSAT (Satellite)		e 230 V	
		EU 230 V CE	

ORDERING EXAMPLE: ▶ LUX-300-SS = CONTROLLER-WATTAGE-FINISH



LUXOR LINKING

With **Luxor Linking**, users can hardwire up to nine Luxor Satellite Controllers, while maintaining a single point of control. The addition of Luxor Satellite Controllers improves Wi-Fi connectivity and brings simplicity to lighting design.



User-Installed Options (order separately)



Wi-Fi Module allows wireless communication to the Luxor controller

Wirelessly assign fixtures with the Light Assignment Module (LAM)

Code	Description
WIFIMOD2	Wi-Fi Module
WIFIMOD2RMT	Wi-Fi Module Remote Mount, Wire Lead 10' (3 m)
LAM	Light Assignment Module

Metal | Powder Coat: Standard



LUXOR Accessories



ZD MR-16

Upgrade any system with MR-16 ZD

The MR-16 ZD is a convenient, high-quality retrofit LED replacement lamp that converts incandescent fixtures to energy-efficient LED fixtures. When connected to a Luxor Controller, the MR-16 ZD adds zoning, dimming, and Wi-Fi control capabilities to any brand of low-voltage lighting fixture — and it carries a five-year warranty.

MODEL CONFIGURATION:

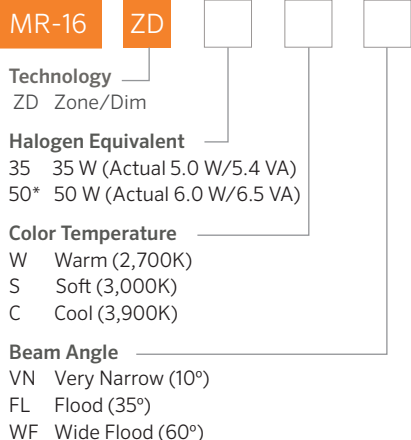

Lamp	Output Equiv	Color Temp	Beam Angle
MR-16 ZD 35	35 W	W Warm (2,700K)	VN Very Narrow (10°)
50*	50 W	S Soft (3,000K)	FL Flood (35°)
		C Cool (3,900K)	WF Wide Flood (60°)

EXAMPLE: LAMP-WATT-TEMPERATURE-BEAM ANGLE ▶ MR16-ZD-35-W-VN

*Title 20 compliant





LOW-VOLTAGE FIXTURES



LINE-VOLTAGE FIXTURES



OUTDOOR ELEMENTS

LUXOR CUBE offers total control for outdoor living spaces

With the Luxor CUBE, the Luxor Controller can zone and dim other brands of low- and line-voltage lighting fixtures. In addition to controlling carriage, entry pillar, and holiday or bistro lights, the CUBE even allows control of water pumps, automatic gates, and any device with a relay input.

TYPE	MODEL NO.	MAX LOAD	SUPPORTS*	NOTES
Low-Voltage	LCM-LV	60 W/5 A	AC Dimmable LEDs	
			Incandescent	Alternate LV Power Source Required
Line-Voltage	LCM-HV	400 W/3.3 A	AC Lighting (Dimmable LED and Incandescent)	Alternate HV Power Source Required
Relay/0-10V	LCM-RLY-010V	250 VAC/5 A	Relay Switch	



LUXOR CUBE MODELS



Low-Voltage **LCM-LV**



Line-Voltage **LCM-HV**



Relay **LCM-RLY-010V**

* See installation instructions for restrictions and advisory information

Total Cloud Control

The Luxor App provides ultimate flexibility and convenience for remote lighting management. With the user-friendly app, you can adjust fixture intensity and color, create unique themes, and fine-tune your color palette for special occasions — from anywhere!

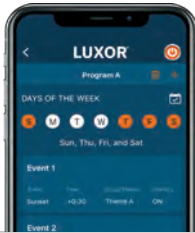
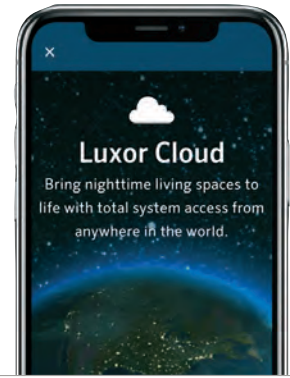

Programming

Create custom lighting schedules for everyday living, holidays, and celebrations.

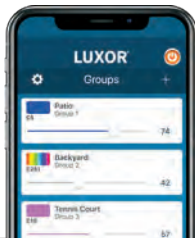

Color Creation

Create up to 30,000 colors using the latest RGBW LED technology.

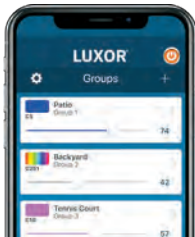

Groups

Adjust intensity and colors of individual or groups of fixtures to fine-tune your lighting design.

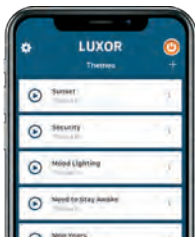

Themes

Design one-of-a-kind holiday displays, create team spirit for the big game, or add company colors for corporate events.



Site Management

Work smarter with simple remote site management and convenient site sharing.

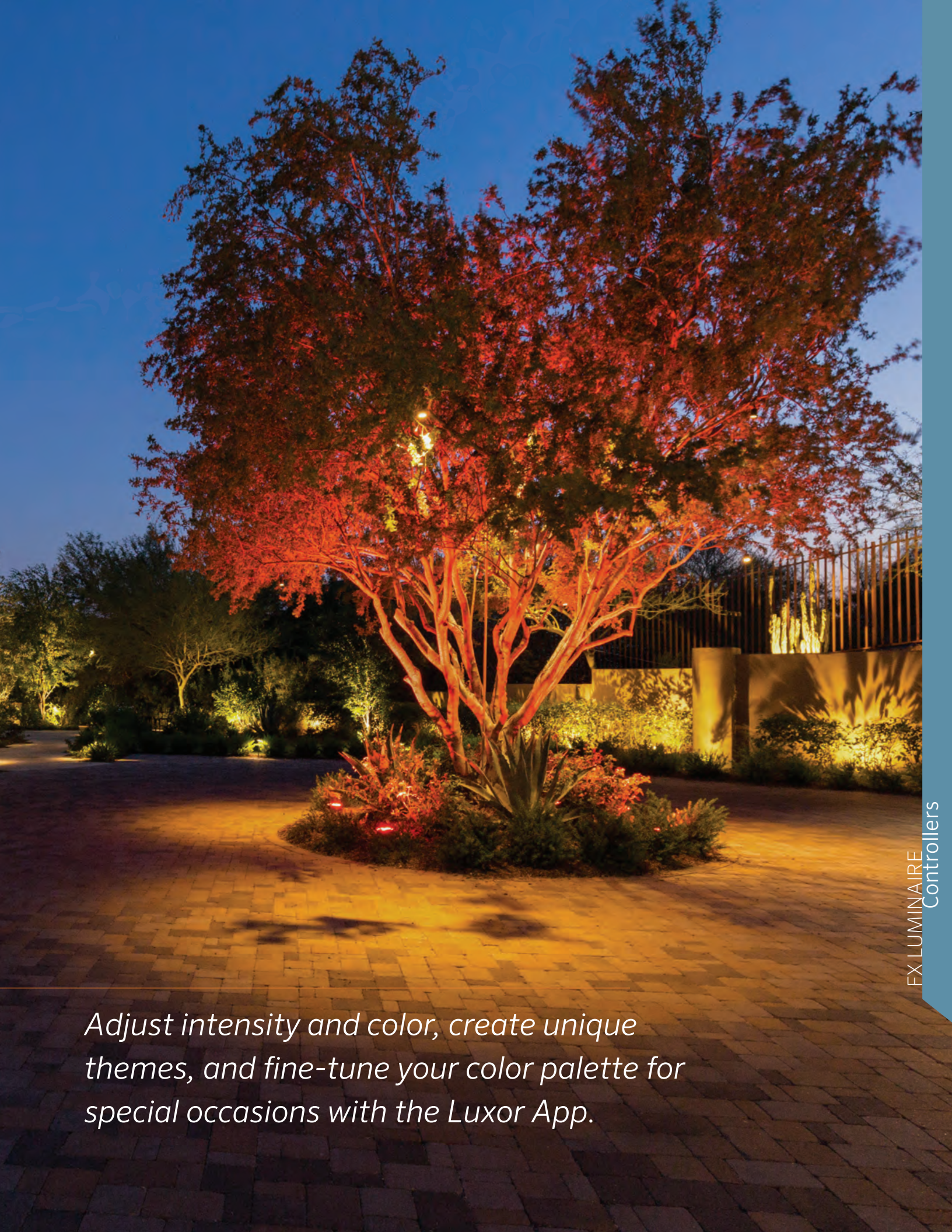

Adjust intensity and color, create unique themes, and fine-tune your color palette for special occasions with the Luxor App.



TRANSFORMERS and Controllers

When you choose an FX Luminaire lighting system, you get the very latest landscape lighting technology, including the highest-quality transformers, no matter your budget.

From intermediate to advanced control options, our transformers offer unsurpassed freedom, flexibility, and performance to elevate any outdoor living space.



FX Luminaire lighting controllers and accessories provide comprehensive lighting control options for standard installations.

EX



Transformer	Wattage	Compliance	Finish
EX	150	150 W [Blank]	120 V SS M
		e	230 V
		230 V (M finish only)	

ORDERING EXAMPLE: ▶ EX150-M = CONTROLLER-WATTAGE-FINISH



Dimensions

Height: 13.0" (330 mm)
Width: 5.5" (140 mm)
Depth: 5.0" (127 mm)

ACCESSORIES: Specify Separately

Name	Code
EXPC	EX Photocell
PXTIMER	PX Timer
PXSYNC	Lighting Synchronizer for 24V Irrigation Controllers
SURGEMOD	Surge Module

DX



Controller	Wattage	Compliance	Finish
DX	150	150 W [Blank]	120 V SS M
	300	300 W	

ORDERING EXAMPLE: ▶ DX150-SS = CONTROLLER-WATTAGE-FINISH



Dimensions

Height: 11.4" (289 mm)
Width: 7.1" (181 mm)
Depth: 5.0" (128 mm)

ACCESSORIES: Specify Separately

Item	Description
DXFP	DX Facepack
LXBATT9V	9 V Battery Adapter
SURGEMOD	Surge Protection Module

Metal | Powder Coat: Standard

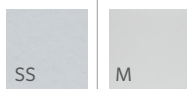

PX



Transformer	Wattage	Switching Option	Compliance	Finish
PX	300	PC	Photocell	[Blank] 120 V SS BZ DG WI SB FB FW** SV
	600	T	Timer	
	900	TPC	Timer/Photocell	

ORDERING EXAMPLE: ▶ **PX600-PC-SS** = CONTROLLER-WATTAGE-SWITCHING OPTION-FINISH



Dimensions

Height:
 300 & 600 W: 13.5" (343 mm)
 900 W: 16.5" (419 mm)
 Width: 7.5" (191 mm)
 Depth: 6.0" (152 mm)

ACCESSORIES: Specify Separately

Item	Description	Item	Description
PXSYNC	Lighting Synchronizer for 24 V Irrigation Controllers	PXPC	PX Photocell
PXTIMER	PX Timer	SURGEMOD	Surge Module
PXPC	PX Photocell		

POWER Accessories

Catalog No.	Description
MT-6W	Mini Plug-in Transformer, 6 W
MT-30W	Mini Plug-in Transformer, 30 W
ST-UV	Step-Down Transformer, 30 W, Universal Voltage (110-277 V) to 12 V
ST-HV	Step-Down Transformer, 16 W, Universal Voltage (110-277 V) to 12 V
ST-120-DIM	Step-Down Transformer, Dimmable, 60 W, 120 V to 12 V
SURGEMOD	Surge Protection Module for LED Lighting Fixtures

Powder Coat: Standard



Powder Coat: Specialty

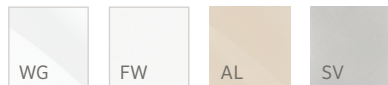

Metal



† Non-returnable * May require longer lead time

LAMPS

MR-16 and G4



With our complete line of high-efficiency MR-16 and G4 LED Lamps, you get more choices for maximum lighting design flexibility. Lamps are available preinstalled in all FX Luminaire Standard Series fixtures.

The 50 W MR-16 LED Lamps are fully compliant with California's strict Title 20 requirements to reduce electricity consumption.



MR-16 LAMPS ARE AVAILABLE IN HIGH-EFFICIENCY MODELS RANGING FROM 20 TO 50 W EQUIVALENTS.

G4 LAMPS PROVIDE A UNIFORM LIGHT DISTRIBUTION ACROSS A RANGE OF BEAM SPREADS.

MR-16 AND G4 LAMPS





MR-16 LED Lamp

The MR-16 LED Lamp is a convenient, energy-saving solution offering the high quality you expect from FX Luminaire. It is available in three intensities, three beam angle options, and three color temperatures. Fully potted, it carries a five-year warranty.

MR-16 LED

MODEL CONFIGURATION: _____

MR-16 **LED**

Halogen Equivalent

- 20 20 W (Actual 4.0 W/4.3 VA)
- 35 35 W (Actual 5.0 W/5.4 VA)
- 50* 50 W (Actual 6.0 W/6.5 VA)

Color Temperature

- W Warm (2,700K)
- S Soft (3,000K)
- C Cool (3,900K)

Beam Angle

- VN Very Narrow (10°)
- FL Flood (35°)
- WF Wide Flood (60°)

Lamp	Output Equiv	Color Temp	Beam Angle
MR-16 LED 20	20 W	W Warm (2,700K)	VN Very Narrow (10°)
35	35 W	S Soft (3,000K)	FL Flood (35°)
50*	50 W	C Cool (3,900K)	WF Wide Flood (60°)

EXAMPLE: LAMP-WATT-TEMPERATURE-BEAM ANGLE ▶ **MR16-LED-20-W-VN**

*Title 20 compliant





MR-16 Eco Lamp

The MR-16 Eco LED Lamp family provides an economical choice for lighting professionals. To simplify product selection, the lamps are available with two outputs, two beam angles, and one color temperature option.

MR-16 Eco

MODEL CONFIGURATION: _____

MR-16 **ECO**

Halogen Equivalent

20 20 W (Actual 4.0 W/6.2 VA)
50 50 W (Actual 6.0 W/9.2 VA)

Color Temperature

W Warm (2,700K)

Beam Angle

FL Flood (35°)
WF Wide Flood (60°)

Lamp	Output Equiv	Color Temp	Beam Angle
MR-16 ECO	20 20 W	W Warm (2,700K)	FL Flood (35°)
	50 50 W		WF Wide Flood (60°)

EXAMPLE: LAMP-WATT-TEMPERATURE-BEAM ANGLE ▶ **MR16-ECO-20-W-FL**





MR-11 Eco

MR-11 Eco Lamp

The versatile MR-11 Eco Lamp offers reliable performance in a small package. Featuring a 2 W output and a 35° beam angle for ample illumination, it's ideal for low-output applications.

MODEL CONFIGURATION: _____

MR-11 ECO

Halogen Equivalent

20 20 W (Actual 2.0 W/3.3 VA)

Color Temperature

W Warm (2,700K)

S Soft (3,000K)

Beam Angle

FL Flood (35°)



Lamp	Output Equiv	Color Temp	Beam Angle
MR11ECO	20 20 W	W Warm (2,700K)	FL Flood (35°)
		S Soft (3,000K)	

EXAMPLE: LAMP-WATT-TEMPERATURE-BEAM ANGLE ▶ **MR11ECO-20-W-FL**





PAR-36 Eco

PAR-36 Eco Lamp

The powerful PAR-36 Eco Lamp is perfect for applications that require a high output. Delivering up to 860 lm, it's available in two intensities, two beam angles, and two color temperatures.

MODEL CONFIGURATION:

PAR-36 ECO

Halogen Equivalent

35 35W (Actual 6.0 W/8.5 VA)
50 50 W (Actual 10.0 W/11.3 VA)

Color Temperature

W Warm (2,700K)
S Soft (3,000K)

Beam Angle

FL Flood (35°)
WF Wide Flood (60°)

Lamp	Output Equiv	Color Temp	Beam Angle
PAR36ECO	35 35 W	W Warm (2,700K)	FL Flood (35°)
	50 50 W	S Soft (3,000K)	WF Wide Flood (60°)

EXAMPLE: LAMP-WATT-TEMPERATURE-BEAM ANGLE ▶ PAR36ECO-50-W-FL





G4 LED

G4 LED Lamp

Specially developed with a clear silicone capsule design, the G4 LED Lamp combines the reliability of FX Luminaire with the convenience of three intensities. The G4 LED features a warm 2,700K and soft 3,000K color temperature and carries a five-year warranty.

MODEL CONFIGURATION:



Halogen Equivalent

- 10 10 W (Actual 1.0 W/1.1 VA)
- 20 20 W (Actual 1.6 W/1.7 VA)
- 35 35 W (Actual 2.4 W/2.6 VA)

Color Temperature

- W Warm (2,700K)
- S Soft (3,000K)

Lamp	Output Equiv	Color Temp
G4 LED	10 10 W	W Warm (2,700K)
	20 20 W	S Soft (3,000K)
	35 35 W	

EXAMPLE: LAMP-WATT-TEMPERATURE ▶ **G4-LED-20-W**





FX Luminaire lamps offer a wide range of output, beam angle, and color temperature options.



At FX Luminaire, we pride ourselves in providing our customers with highly detailed technical information and useful tools to make even the most complex projects simple, seamless, and straightforward.

From comprehensive photometrics data charts to our handy finish guide, we have the information you need to create world-class lighting designs in every installation.



TECHNICAL DATA

Finishes, Photometrics,
and Lighting



FX LUMINAIRE FIXTURES
ARE FIELD ADJUSTABLE,
SERVICEABLE, AND
UPGRADEABLE.

BUILT-IN OPTICS
PLATFORMS PROVIDE A
SIMPLE CONFIGURATION
FOR ADJUSTING COLOR
TEMPERATURE AND
BEAM ANGLE SPREADS.

ALL FX LUMINAIRE LED
SYSTEMS ARE CAREFULLY
ENGINEERED FOR OPTIMAL
PERFORMANCE ACROSS A
RANGE OF APPLICATIONS.

FX LUMINAIRE Finishes

Metal



AB on copper
Antique Bronze



AB on brass
Antique Bronze



AT on copper
Antique Tumbled

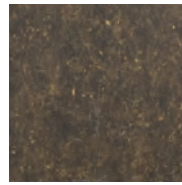

AT on brass
Antique Tumbled



CU
Copper

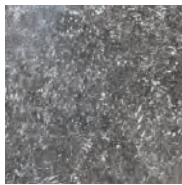

NP
Nickel Plate



BS
Natural Brass

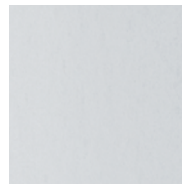

SS
Stainless Steel

Powder Coat: Standard



BZ
Bronze Metallic

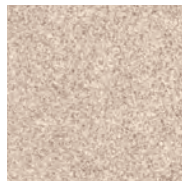

DG
Desert Granite

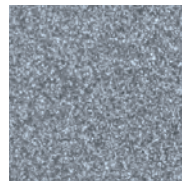

WI
Weathered Iron



SB
Sedona Brown



FB
Black



M
Matte Gray
(Select transformers only)

Powder Coat: Specialty



FW
Flat White



SV
Silver
(Select fixtures only)

Composite



CB
Camo Bronze

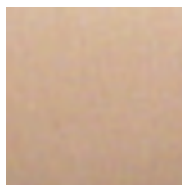

DT
Desert Tan

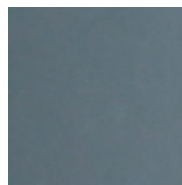

DS
Dark Slate

FX LUMINAIRE Photometrics

Use our photometrics charts to make the most of your lighting design. The charts help with ideal fixture spacing by illustrating light intensity at variable distances. Visit the product pages at fxl.com for photometric charts specific to each fixture.

Mounting height or distance from illuminated surface

MS 1LED ILLUMINANCE AT DISTANCE

This column is the forward throw of the light

Mounting height or distance from illuminated surface	Center Beam	Beam Width	
		Horizontal (92°)	Vertical (85°)
2.0' (0.6 m)	11.6 fc (125.3 lux)	3.6' (1.1 m)	4.1' (1.2 m)
4.0' (1.2 m)	2.9 fc (31.3 lux)	7.3' (2.2 m)	8.2' (2.5 m)
6.0' (1.8 m)	1.3 fc (14 lux)	10.9' (3.3 m)	12.3' (3.7 m)
8.0' (2.4 m)	0.5 fc (5.4 lux)	14.6' (4.5 m)	16.4' (4.9 m)
10.0' (3.0 m)	0.3 fc (3.2 lux)	18.2' (5.5 m)	20.5' (6.2 m)

Foot-candles (or lux) measure light output density at a given point

Horizontal Spread
Vertical Spread

Sideways spread of the beam

HORIZONTAL AND VERTICAL THROW OF LIGHT (TOP VIEW)

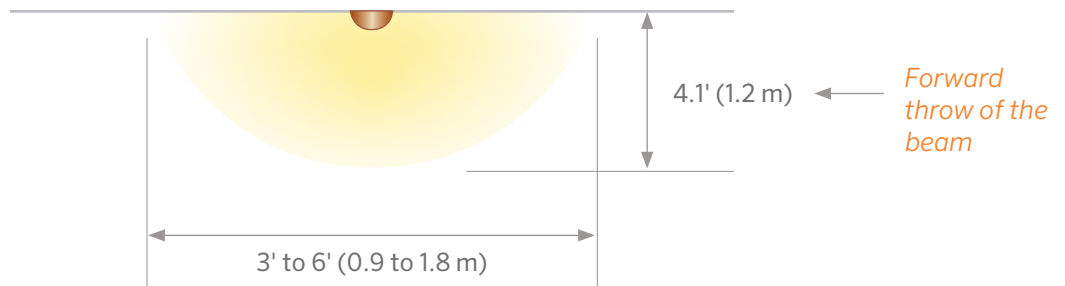

HORIZONTAL THROW OF LIGHT (FRONT VIEW)

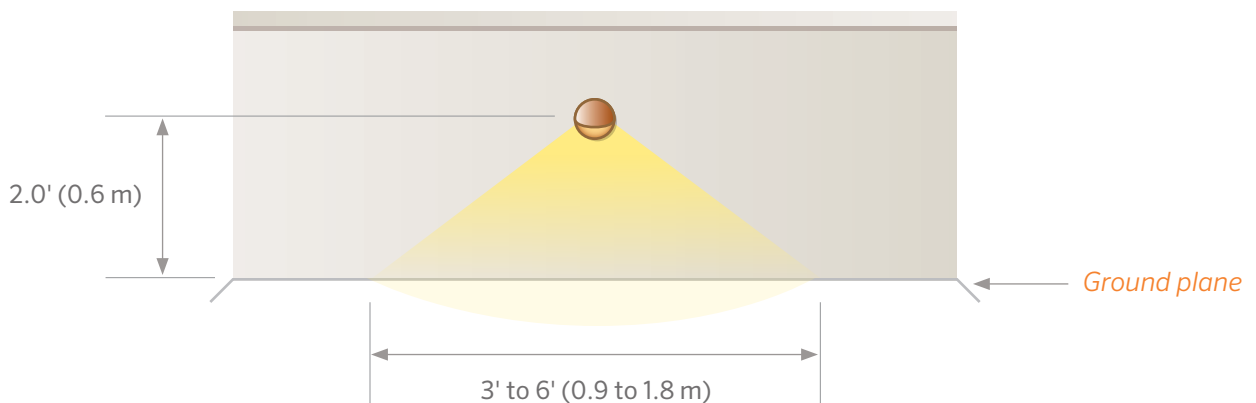



Control
Luxor shown



Up Lights
NP shown



Path Lights
CA shown



Wall Lights
LF shown

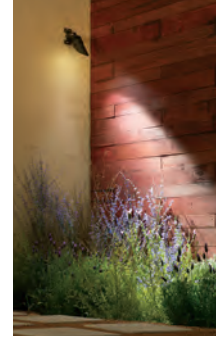

Down Lights
JB shown



Wall Wash
PB shown

Intensity

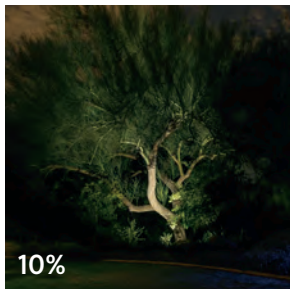

10%

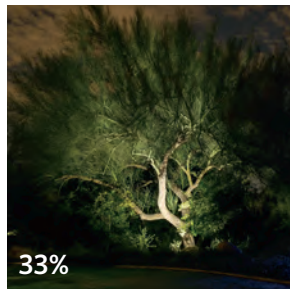

33%



66%

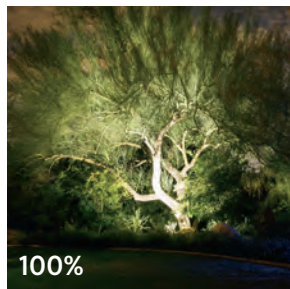

100%

Look on the *Bright Side*

With Luxor Technology, up to 250 independently adjustable lighting groups can be created with fixtures that have a 1, 3, 6, or 9 LED capacity. All groups can be turned on independently and dimmed from 1-100%.

Color Temperature

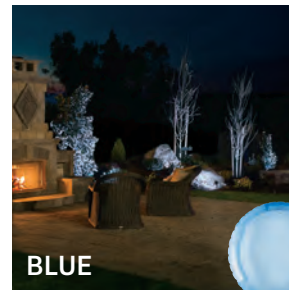

BLUE

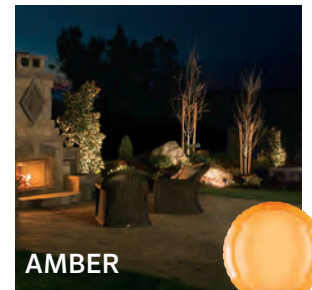

AMBER

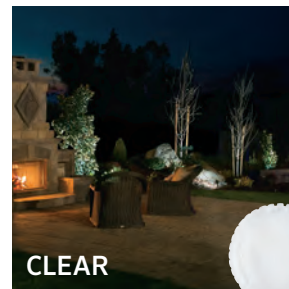

CLEAR

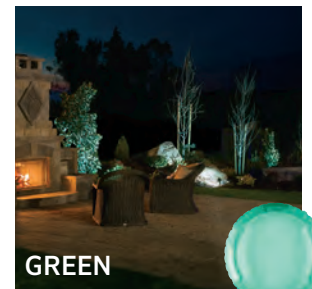

GREEN



A Spectrum of *Possibilities*

Adjust color temperature filters to match vegetation and architecture for distinctive looks year round. The Luxor Controller provides the ability to create 30,000 colors using the latest LED technology.

Beam Spread

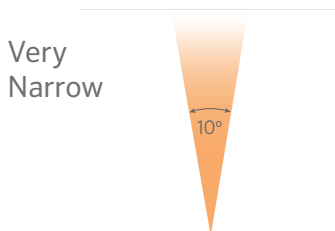

Very Narrow

10°

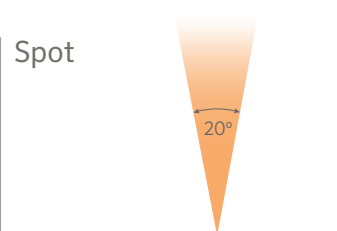

Spot

20°

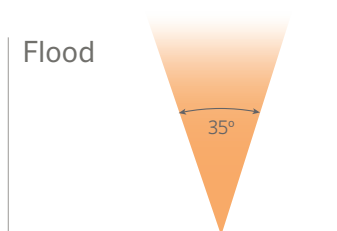

Flood

35°

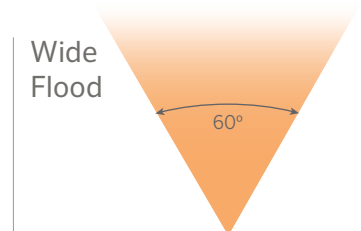

Wide Flood

60°

All the Right *Angles* FX Luminaire integrated LEDs offer many beam angle options for maximum lighting design flexibility.

Adjust to your preference using very narrow, spot, flood, or wide flood lenses ranging from 10° to 60°.



STOP INGRESS IN ITS TRACKS WITH *MoistureBlock™*

Over time, lighting fixtures can experience moisture ingress through the cable entry. As the lamp heats up, air inside the fixture expands and is forced into the cable. When the lamp cools after the fixture is turned off, the air contracts and creates suction inside the fixture and the cable. This causes moisture ingress, which can lead to internal corrosion and electrical failure.

FX Luminaire fixtures have built-in, 100% watertight MoistureBlock Technology to maximize the longevity of every lighting installation.

Sockets with MoistureBlock



EXTERIOR SEALS

CHEMICAL BONDING AGENTS

SOLDERED COPPER STRANDS

EPOXY-FILLED TERMINAL CAVITIES

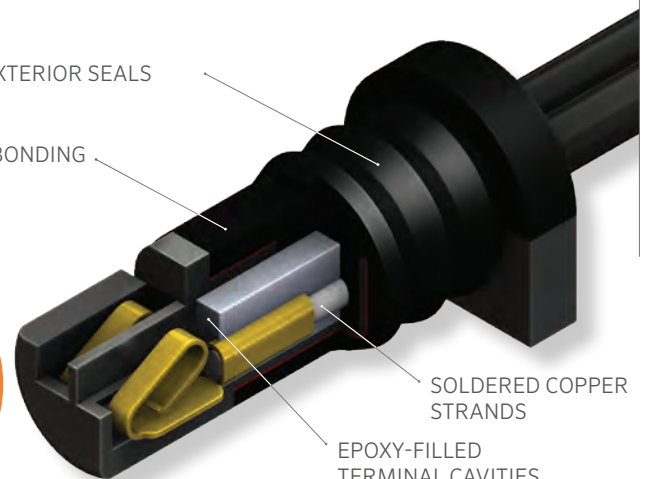

ACCESSORIES

and Replacement Parts

SPIKES, LED BOARDS, AND MOUNTS

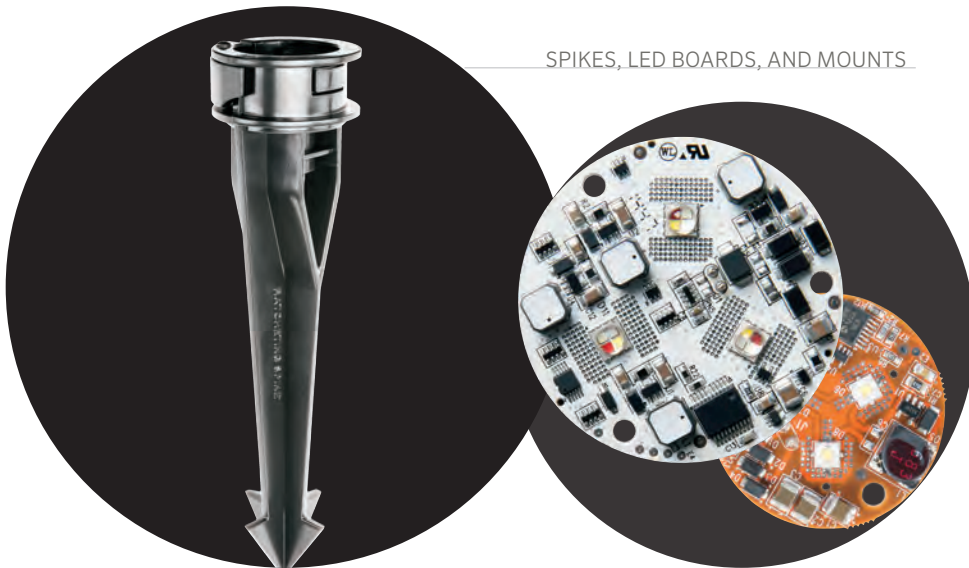



EX Luminaire offers an assortment of accessories to enhance your lighting design. From spikes and risers to mounting kits, lenses, splicing options, and more, we have the accessories you need to transform your vision into reality.

Our mounting options include surface mounts such as junction boxes and wall plates, ground mounts such as conduits and spikes, and a full range of couplers and risers.

DESIGNER SERIES Replacement Kits



LED REPLACEMENT KITS

Order No.	Description
1LEDULKIT	1 LED Replacement Kit†
3LEDULKIT	3 LED Replacement Kit†
6LEDULKIT	6 LED Replacement Kit†
9LEDULKIT	9 LED Replacement Kit†
755903	1 LED Board for LF Ledge Light (Warm: 2,700K)*
755904	1 LED Board for LF Ledge Light (Cool: 3,900K)*

Includes Filters, Screws, Reflectors, and LED Board

ZDC DESIGNER SERIES Replacement Kits

Order No.	Description
ZDCKITL	ZDC Replacement Kit (Large)
ZDCKITM	ZDC Replacement Kit (Medium)
ZDCKITR	ZDC Replacement Kit (Rectangular)*

ZDC Kit includes Board, Reflector, Optic, and Optic Holder

DESIGNER SERIES Optics Kits



LED OPTICS

Order No.	Description
1LED OPTICKIT	Optics Kit for 1 LED Board
3LED OPTICKIT	Optics Kit for 3 LED Board
9LED OPTICKIT	Optics Kit for 9 LED Board

DESIGNER SERIES Beam Angle Lens



BEAM ANGLE LENS

Order No.	Description
1LEDFLENS	1 LED Flood Lens, 35°
1LEDWFLENS	1 LED Wide Flood Lens, 60°
3LEDFLENS	3 LED Flood Lens, 35°
3LEDWFLENS	3 LED Wide Flood Lens, 60°
9LEDFLENS	6 and 9 LED Flood Lens, 35°
9LEDWFLENS	6 and 9 LED Wide Flood Lens, 60°

ZD DESIGNER SERIES Replacement Kits



LED REPLACEMENT KITS

Order No.	Description
ZD1LEDULKIT	ZD 1 LED Replacement Kit†
ZD3LEDULKIT	ZD 3 LED Replacement Kit†
ZD3LEDTKIT	ZD 3LED Wildlife-friendly Replacement Kit
ZD6LEDULKIT	ZD 6 LED Replacement Kit†
ZD9LEDULKIT	ZD 9 LED Replacement Kit†
755905	ZD 1 LED Board for LF (Warm: 2,700K)*
755906	ZD 1 LED Board for LF (Cool: 3,900K)*

Includes Filters, Screws, Reflectors, and LED Board

COLOR Filters

Order No.	Description
250015170000	Frosted Lens for MR-16
250010480000	Frosted Lens for MR-11
250015240000	Solite Spread for MR-16
250015420000	Solite Spread for MR-11
250013550000	Spread Lens for MR-16
250015160000	Spread Lens for CG
250015260000	Hex Baffle for MR-16
250015250000	Hex Baffle for MR-11
RRMR16	RecessorRing® Spacer for MR-16
250015180000	Color Filter for MR-16 Light Green
250015190000	Color Filter for MR-16 Light Blue
250015230000	Color Filter for MR-16 Dichroic Peach
250015200000	Color Filter for MR-16 Dichroic Blue
250015210000	Color Filter for MR-16 Dichroic Green
250015220000	Color Filter for MR-16 Dichroic Red
250010140000	Color Filter for MR-11 Dichroic Peach
250010160000	Color Filter for MR-11 Dichroic Blue

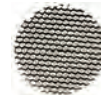

HEX BAFFLES



RECESSORRING SPACER



COLOR FILTERS

†Can be used in down lights *Board only

MOUNTING Options



Order No.	Description
POST AND DECK MOUNTS	
PM-XX**	Post Mount
PDM-XX**	Deck Mount for PM
GM-XX**	Ground Mount
VERSABOX	
VB-050-XX**	VersaBox for 1/2" Thread
VB-TS-XX**	VersaBox for TS
MINI J-BOX	
MJB-050-XX**	Mini J-Box for 1/2" Thread
MJ-TS-XX**	Mini J-Box for TS
GUTTER MOUNT	
GM-SS	Gutter Mount for 1/2" Thread Accent Lights
TREEBOX MOUNT	
TB-XX**	TreeBox with 1/2" thread
IN-GRADE	
LG-NF	Light Guard
SPIKES	
250030410000SP	Lock Ring for 1/2" Thread Accent Lights (Order Qty 25)
753900	Super Slot Spike
250015840000	Long Slot Spike
SJ-XX**	Super J-Box Spike
250011560000	CDS Spike
250020020000	Three-Prong Spike
PARS	ProAim Ratcheting Spike
EKITSPIKE	Junction Box Spike Kit
CSKITMPL	Conduit Stabilizer Kit for M-PL, M-PK, and M-PZ Modern Path Lights
CSKITMPJ	Conduit Stabilizer Kit for M-PJ Modern Path Light



MOUNTING Options (cont.)



Order No.	Description
WALL MOUNTS	
POBRKT	PO Mounting Bracket
MOBRKT	MO Mounting Bracket
MM-050-XX**	Mini Mount
WM-XX**	Wall Mount Knuckle
WP-1G-050-XX**	Wall Plate, 1-Gang, 1/2" Thread
WP-RD-050-XX**	Wall Plate, Round, 1/2" Thread
WP-2G-NL-XX**	Wall Plate, 2-Gang, NL Surface-Mounted Wall Light
WP-RD-PS-XX**	Wall Plate, Round, PS Surface-Mounted Down Light
EKITWALL	Wall Light Connection Kit

POWER Accessories

Catalog No.	Description
MT-6W	Mini Plug-in Transformer, 6 W
MT-30W	Mini Plug-in Transformer, 30 W
ST-UV	Step-Down Transformer, 30 W, Universal Voltage (110-277 V) to 12 V
ST-HV	Step-Down Transformer, 16 W, Universal Voltage (110-277 V) to 12 V
ST-120-DIM	Step-Down Transformer, Dimmable, 60 W, 120 V to 12 V
SURGEMOD	Surge Protection Module for LED Lighting Fixtures

SPLICING Options



Order No.	Description
WCHSSM20	LightingShrink™ Wire Connectors, Small (20-Pack)
WCHSMD20	LightingShrink Wire Connectors, Medium (20-Pack)
WCHSTOOL	LightingShrink Ratcheting Crimper Tool
WCHSBS2	Brass Lug Connectors with Allen key and heat shrink wrap (2-pack)
WCHSBS50	Brass Lug Connectors with Allen key and heat shrink wrap, 50 pcs loose in box (50 bulk)

** Denotes powder coat finish

ALUMINUM RISER Options



Riser Height		Coupling Option		Finish
6R	6" (150 mm)	[blank]	Riser Only	BZ DG WI FB SB FW** SV**
8R	8" (200 mm)	COUP	Straight Coupling	
12R	12" (300 mm)	90	90° Coupling	
18R	18" (450 mm)	T	T Coupling	
24R	24" (600 mm)			
30R	30" (750 mm)			
36R	36" (900 mm)			

ORDERING EXAMPLE: ▶ **12R-COUP-BZ** = RISER HEIGHT-OPTION-FINISH

COPPER RISER Options



Riser Height		Finish
8R-GT	8" (200 mm)	BZ DG WI FB SB FW** SV** CU AB** AT** NP**
12R-GT	12" (300 mm)	
18R-GT	18" (450 mm)	
24R-GT	24" (600 mm)	

ORDERING EXAMPLE: ▶ **18R-GT-CU** = RISER HEIGHT-FINISH

OTHER MOUNTING Options



Item	Description
VHRUL	Variable Height Riser for Up Light, Extends 0"-7" (0-178 mm)
COUP-XX**	Straight Coupling, ½"
ELBW-050-XX**	90° Elbow Fitting, ½"
TMNT-050-XX**	T-Mount Fitting, ½"
24R-SL-XX**	24" (600 mm) Sign Light Riser
36R-SL-XX**	36" (900 mm) Sign Light Riser
48R-SL-XX**	48" (1200 mm) Sign Light Riser
TR-18-6P-XX**	Tree Ring, 18" (450 mm) Diameter, 6-Position (BZ and FB only)
TR-24-6P-XX**	Tree Ring, 24" (600 mm) Diameter, 6-Position (BZ and FB only)
TR-JB-LL-XX**	Tree Ring, Junction Box, LL Style Conduit Body (BZ and FB only)
TR-JB-T-XX*	Tree Ring, Junction Box, T Style Conduit Body (BZ and FB only)

+ Non-returnable * May require longer lead time ** Finish code

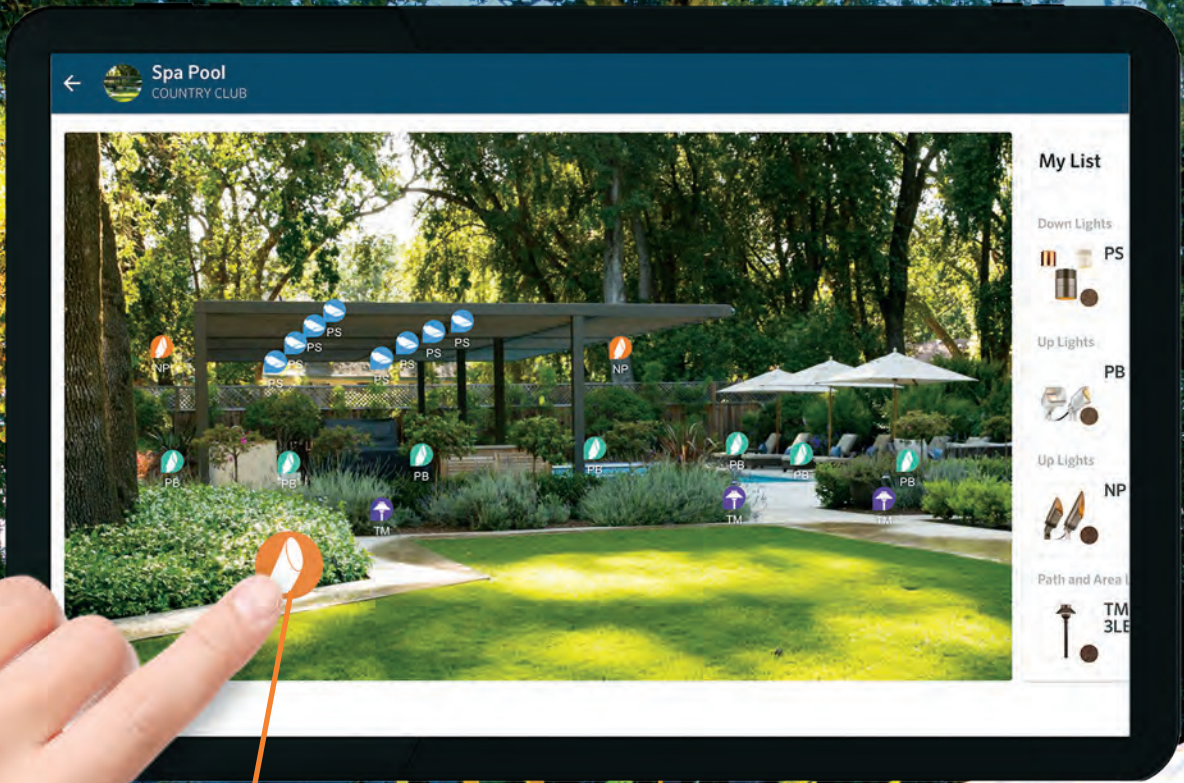

Design like a pro and impress your customers with the award-winning online My Design tool — no technical skills required!



<https://fxl.com/My-Design>



FX Luminaire puts all the resources you need to succeed at your fingertips. Gain the power to install with confidence, troubleshoot with ease, maximize energy savings, and sell with assurance.

Connect with us on social media to share the latest product news and other important information with your customers.





Education, Tools, and Support



MY LIST



MARKETING SUPPORT



HUNTER UNIVERSITY



DEMO KITS

From product knowledge to marketing support, we offer a full suite of tools, services, and programs to help your business grow.

DISCOVER YOUR Path to Success



MY LIST AND MY DESIGN

Simplify Your Design and Ordering Process

Use these simple, yet powerful tools to create designs, plan installations, send your order directly to distributor branches, and add notes to specific projects.

My List and My Design helps you customize unique proposals for every customer and streamline orders for your business.



MARKETING SUPPORT

Access Helpful Marketing Support Materials

We're dedicated to helping you grow and maintain your business. Build your own branded marketing materials at fxl.com/professionals.

CUSTOMIZABLE PRINT MARKETING

- ▶ Door Hangers
- ▶ Postcards
- ▶ Why FX Brochure
- ▶ Yard Signs
- ▶ Path Light Product Guide
- ▶ Homeowner Brochure
- ▶ Truck Magnets



HUNTER UNIVERSITY

Lighting Technician and Lighting Designer Courses

Gain valuable knowledge for both technical and artistic aspects of landscape lighting. These comprehensive, free online programs guide you through the fundamentals of lighting, product selection, and best practices for lighting spaces in any landscape.

Get started today at training.hunterindustries.com

Complete courses with a score of at least 80% and receive certificates of completion.



LUXOR DEMO KIT

Bring the Customer Experience to Light

With our Luxor Demo Kit, you can create an immersive, at-home experience for customers that showcases the unmatched quality of our lighting products. This leads to higher rates of customer satisfaction, trust in your services, and strong profits.

DEMO KIT INCLUDES

- ▶ Luxor Controller
- ▶ Metal transformer base
- ▶ Four 40' (12 m) rolls of studded 12/2 (2 mm) wire (250011790001) with wire nuts
- ▶ Four ZDC NP Up Lights
- ▶ Two ZDC LC Wall Wash Up Lights
- ▶ Two ZDC RW Path Lights
- ▶ Wireless Light Assignment Module (LAM)
- ▶ Luxor Wi-Fi Module (WIFIMOD2)
- ▶ One 10' (3 m) RJ-11 communication cable
- ▶ Eight stability flanges (PDK-BZ)
- ▶ Alligator clips prewired on all fixtures
- ▶ Storage and transportation case, with rubber-coated wheels, pull-out handle, and foam cutouts



*All fixtures are powder-coated in orange or orange/black two-tone configuration.

Order code:

FXPRO-025 North American Luxor Demo Kit

FXPRO-026 International Luxor Demo Kit

FXPRO-027 North American Standard Series Demo Kit

Visit fxl.com/professionals to access more helpful tools and resources — **for free!**

CE Certified Lighting Products



This chart provides special installation notes and IP ratings for select FX Luminaire lighting products. Reference the indicated pages for further information.

Category	Product	Special Requirements	IP	Page
Power and Control	Luxor	Select export (EU) SKU	54	116
Power and Control	EX	Select export (e) SKU	--	123
Up Light	CC	Install with ground mount (GM-XX) accessory	65	17
Up Light	FB	Select export (e) SKU or install with ground mount (GM-XX) accessory	65	15
Up Light	FR	Install with ground mount (GM-XX) accessory	65	16
Up Light	LO	Install with ground mount (GM-XX) accessory	65	58
Up Light	LR	Install with ground mount (GM-XX) accessory	65	59
Up Light	MU	Select export (e) SKU	65	58
Up Light	NP	Select export (e) SKU or install with export spike (eKITSPIKE) accessory	65	15
Up Light	NR	Install with ground mount (GM-XX) accessory	65	16
Up Light	QB, QZ	Install with ground mount (GM-XX) accessory	65	18
Up Light	RS	Install with ground mount (GM-XX) accessory	65	57
Up Light	RW	Install with ground mount (GM-XX) accessory	65	27
Up Light	VS	Install with export spike (eKITSPIKE) accessory	54	17
Wall Wash	PB	Select export (e) SKU or install with export spike (eKITSPIKE) accessory	65/54	19
Wall Wash	LC	Select export (e) SKU or install with ground mount (GM-XX) accessory	65	19
Path/Area Light	CA, DM	Install with ground mount (GM-XX) accessory	65	24, 66
Path/Area Light	DL, DL-A, DM-A, CA-A	Install with ground mount (GM-XX) accessory	65	65, 66, 67
Path/Area Light	GN	Install with ground mount (GM-XX) accessory	65	70
Path/Area Light	HC	Install with ground mount (GM-XX) accessory	65	23
Path/Area Light	PF, SC	Install with ground mount (GM-XX) accessory	65	23, 66
Path/Area Light	SP, SP-A	Install with ground mount (GM-XX) accessory	65	65, 67
Path/Area Light	TM	Install with ground mount (GM-XX) or with export spike (eKITSPIKE) accessory	65/54	25, 68

Category	Product	Special Requirements	IP	Page
Path/Area Light	FG, TD	Install with ground mount (GM-XX) accessory	64	71, 26
Path/Area Light	JS	Install with ground mount (GM-XX) accessory	65	24
Path/Area Light	PL	Install with ground mount (GM-XX) accessory	65	25, 68
Path/Area Light	PM	Select export (e) SKU	65	27
Path/Area Light	M-PL, M-PJ, M-PK, M-PZ	Select export (e) SKU	65, 66, 66, 66	28, 29
Wall Light	CP	Install with export wall light kit (eKITWALL) accessory	64	35, 77
Wall Light	HS	Select export (e) SKU	66	34
Wall Light	LF	Select export (e) SKU	65	33
Wall Light	LM	Install with export wall light kit (eKITWALL) accessory	64	35, 77
Wall Light	MO	Install with export wall light kit (eKITWALL) accessory	65	38
Wall Light	MS	Select export (e) SKU	65	33
Wall Light	PD	Install with export wall light kit (eKITWALL) accessory	64	36, 78
Wall Light	PO	Install with export wall light kit (eKITWALL) accessory	64	37
Wall Light	UN	Install with export wall light kit (eKITWALL) accessory	64	36, 78
Pendant	LE, VE	Select export (e) SKU	64	45
Down Light	JB, DE	Select export (e) SKU or install with TreeBox (TB-XX)	65/64	43, 44
Down Light	MD	Select export (e) SKU	65	83
Down Light	PS, NL	Install with external wall plate kit	64	46
Down Light	QT	Install with TreeBox (TB-XX)	64	43
Down Light	QL	Select export (e) SKU	67	47
In-Grade	FC	Select export (e) SKU	67	51, 89
In-Grade	KG	Select export (e) SKU	67	51
In-Grade	RP, TE	Select export (e) SKU	67	89, 90
Underwater	LB	Select export (e) SKU	67	91
Underwater	LP, LL	Select export (e) SKU	67/68	53

STATEMENT OF Warranty

Hunter Industries Incorporated (“Hunter”) warrants FX Luminaire (“FX”) Transformers to be free of defects in materials or workmanship under normal use for a period of ten (10) years from the original date of installation. Hunter warrants FX Low-Voltage Lighting Fixtures to be free of defects in materials or workmanship under normal use for a period of three (3) years from the original date of installation. Hunter extends the warranty on FX Fixtures to ten (10) years from the original date of installation when both FX Fixtures and Transformers are installed on the same project exclusive of any competitor’s product. Hunter warrants FX LED Fixtures to be free of defects in materials or workmanship under normal use for a period of ten (10) years from the original date of installation. MR-16 LED Lamps, MR-16 ZD Lamps, G4 LED Lamps, Luxor CUBE Devices, SRP Strip Lights, and Line-Voltage Series Fixtures are warranted for five (5) years. MR-16 Eco Lamps, MR-11 Eco Lamps, and PAR-36 Eco Lamps are warranted for three (3) years. If a defect in an FX product is discovered during the applicable warranty period, Hunter will repair or replace the product or the defective part, at its discretion. This warranty does not extend to repairs, adjustments, or replacement of an FX product or part that results from misuse, negligence, alteration, modification, tampering, or improper installation and/or maintenance of the product. This warranty extends only to the original installer of the FX product. If a defect arises in an FX product or part during the warranty period, you should contact your local FX Authorized Distributor.

FX’S OBLIGATION TO REPAIR OR REPLACE ITS PRODUCTS AS SET FORTH ABOVE IS THE SOLE AND EXCLUSIVE WARRANTY SET FORTH BY FX. THERE ARE NO OTHER WARRANTIES, EXPRESSED OR IMPLIED, INCLUDING WARRANTIES OF MERCHANTABILITY AND FITNESS FOR A PARTICULAR PURPOSE. FX WILL NOT BE LIABLE TO DISTRIBUTOR OR ANY OTHER PARTY IN STRICT LIABILITY, TORT, CONTRACT, OR ANY OTHER MANNER FOR DAMAGES CAUSED OR CLAIMED TO BE CAUSED AS A RESULT OF ANY DESIGN OR DEFECT IN FX’S PRODUCTS, OR FOR ANY SPECIAL, INCIDENTAL, CONSEQUENTIAL, OR EXEMPLARY DAMAGES OF ANY NATURE, INCLUDING WITHOUT LIMITATION LOST BUSINESS OR PROFITS. NOTWITHSTANDING THE FOREGOING, IF FOR ANY REASON FX IS FOUND TO BE LIABLE IN NO EVENT SHALL FX’S LIABILITY EXCEED THE PRICE OF THE PRODUCT WHICH GIVES RISE TO THE CLAIM, LOSS, OR DAMAGE.

Any FX product being returned must receive approval and a Return Goods Authorization number from Hunter Customer Service prior to sending product back. All returned product is subject to a 25 percent restocking fee. Product must be returned within six (6) months of order date. All product returned must be in its original packaging, be undamaged and unused and never energized. Product not meeting these criteria will be returned to original sender. Line-Voltage Series Fixtures are not returnable. Products with specialty finishes are not returnable. Specialty finishes include (but are not limited to): Almond (AL), Verde Speckle (VF), Silver (SV), Flat White (FW), White Gloss (WG), Black Wrinkle (BF), White Wrinkle (WF), and Nickel Plate (NP). Hunter Industries is not responsible for product loss or damage during return transit to RMA location.

If you have questions concerning the warranty or its application, please write to:

Customer Service Department
FX Luminaire
1940 Diamond Street
San Marcos, CA 92078 USA

Index

A		E		M		R	
AL	72	EX	123	MD	83	RC	42
A-BR-10	105	F		MM	78	RISER/COUPLING	143
A-CT-4	105	FB	15	MO	38	RISERS	143
A-CT-5	105	FB LED	15	MOUNTING OPTIONS	142	RL	62
A-HS	107	FC	89	MP	57	RP	89
A-KN	107	FC LED	51	M-PL	29	RS	57
A-NK-4	106	FG	26	M-PJ	28	RW	27
A-NK-6	106	FG LED	71	M-PK	28	S	
A-ST-5	106	FR	16	M-PZ	29	SC LED	66
B		G		MR	59	SC LED	23
BEAM ANGLE LENS	141	G4 LED LAMP	131	MR-11 ECO LAMP	129	SD	42
BQ	52	GN	70	MR-16 LED LAMP	127	SL	38
C		GT	70	MR-16 ECO LAMP	128	SP	65
CA	66	H		MS	33	SP-A	67
CA LED	24	HC LED	23	MU	58	SPIKES	142
CA-A	67	HEX BAFFLES	141	N		SRP	91
CC	17	HP	52	NL	46	T	
C-DL	83	HS	34	NP	15	TC	84
CF	90	J		NR	16	TD	71
CG	75	JB	43	P		TD LED	26
C-IN	90	JS	24	PAR36 ECO LAMP	130	TE	90
CL	84	K		PB	19	TM	68
C-LL	79	KG	51	PD	36	TM LED	25
CP	77	KT	52	PD LED	78	TREE RING	143
CP LED	35	L		PF	66	TS	85
C-PL-4	69	LB	91	PF LED	23	U	
C-PL-7	69	LC	19	PL	25	UN	78
C-UL	60	LD	79	PL LED	68	UN LED	36
CV	66	LE	45	PM	27	V	
CV LED	24	LF	33	PM LED	27	VC	47
C-WW	61	LL	53	PO	37	VE	45
C-WW-L	61	LM	77	PR	66	VL	85
D		LM LED	35	PR LED	23	VO	37
DE	44	LO	58	PS	46	VS	17
DL	65	LP	53	PX	124	W	
DL-A	67	LR	59	Q		WALL MOUNTS	142
DM	66	LS	85	QB	18	WS	62
DM LED	24	LUXOR	115	QL	47	WIFIMOD2	116
DM-A	67	LUXOR CUBE	118	QT	43	WIFIMOD2RMT	116
DR	73			QZ	18	Z	
DS	73					ZC	41
DX	123					ZD MR-16 LED LAMP	117
						ZW	41

FXLuminaire

A Hunter Industries Company

Our mission is to create the most energy-efficient lighting products in the world while maintaining the highest level of quality and reliability. In every instance we will back our innovations with the unwavering support our customers need to succeed.



Gregory R. Hunter, CEO of Hunter Industries



Gene Smith, President, Landscape Irrigation and Outdoor Lighting

Website fxl.com | Customer Support +1-760-744-5240 | Technical Service +1-760-591-7383

USA HEADQUARTERS

1940 Diamond Street
San Marcos, CA 92078 USA
T: +1-760-744-5240
E: support@fxl.com

MEXICO MANUFACTURING

ISO 9001:2015 Certified
Calle Nordika #8615
Colonia la Joya
Parque Industrial Nordika
Tijuana, B.C., Mexico CP 22640
T: +011-52-664-903-1382
E: infolatam@hunterindustries.com

EUROPE

Avenida Diagonal 523, 5o-2a
Edificio Atalaya
08029 Barcelona, Spain
T: +34 9-34-94-88-81
E: infoeurope@hunterindustries.com

AUSTRALIA

Suite 7, 202 Ferntree Gully Road
Notting Hill, VC 3168, Australia
T: +61 3-9562-9918
F: +61 3-9558-6983
E: infopacrim@hunterindustries.com

MIDDLE EAST

P.O. Box 2370
Amman, 11941, Jordan
T: +962 6-5152882
F: +962 6-5152992
E: info.me@hunterindustries.com

CHINA

B1618, Huibin Plaza.
No. 8, Beichen Dong Street
Beijing 100101, China
T/F: +86 10-84975146
E: infochina@hunterindustries.com

This brochure was printed on Forest Stewardship Council® (FSC) certified paper with soy inks. The FSC is an international organization established to promote the responsible management of the world's forests.

© 2021 Hunter Industries™. Hunter, FX Luminaire, all related logos, and all other trademarks are property of Hunter Industries, registered in the U.S. and other countries.  Please recycle.



FXLIT-183 V32 9/21